



Industrial-Grade Impact Sockets



Built To Be Bold
Quality Never Looked So Good

BUILTTM
TO BE BOLD
Quality Never Looked So Good

Sure, our sockets look great. But underneath their sleek, electro-phosphate finish lies a product with a heart of impact-grade steel. Sockets that are built to be tough. Built to be bold. Built to be Ingersoll Rand.

Bien sûr, nos douilles sont très belles. Mais, sous leur élégante finition électro-phosphatique, elles cachent un cœur d'acier à l'épreuve des chocs. Des douilles construites avec la robustesse en tête. Construites pour se distinguer. Construites pour être à l'image d'Ingersoll Rand.

Ja, sicher – unsere Steckschlüsseinsätze sehen gut aus. Aber unter dem eleganten Elektrophosphat-Finish befindet sich ein Produkt mit einem Herz aus schlagsicherem Stahl. Steckschlüsseinsätze, die vom Konzept her robust und leistungsstark sind. Steckschlüsseinsätze von Ingersoll Rand.

Sin lugar a dudas, nuestras bocas para llaves tienen un aspecto inmejorable. Pero debajo del reluciente acabado de electrofosfato hay un producto con un corazón de acero a prueba de impactos. Bocas fabricadas para ser resistentes. Fabricadas para destacarse. Fabricadas para ser Ingersoll Rand.

Certo, le nostre chiavi a bussola hanno un bellissimo aspetto. Ma sotto l'elegante finitura per elettrofosfatazione c'è un prodotto con un cuore di acciaio antiurto. Sono costruite per durare. Sono costruite per essere robuste. Sono costruite per essere Ingersoll Rand.

Impact Sockets

Table of Contents



Intro	2	1/2" Drive	12
Introduction		Entraîneur de 1/2"	
Einführung		1/2-Zoll-Antrieb	
Introducción		Llave de 1/2"	
Introduzione		Attacco da 1/2"	
Features and Benefits	3	3/4" Drive	16
Caractéristiques et avantages		Entraîneur de 3/4"	
Leistungsmerkmale und Vorteile		3/4-Zoll-Antrieb	
Características y beneficios		Llave de 3/4"	
Caratteristiche e vantaggi		Attacco da 3/4"	
Sockets Product Information	4	1" Drive	19
Informations techniques sur les douilles		Entraîneur de 1"	
Steckschlüsseleinsätze — Produktinformationen		1-Zoll-Antrieb	
Información sobre bocas		Llave de 1"	
Informazioni sulle bussole		Attacco da 1"	
Model Number Configurator	5	Safety	23
Configurateur de numéros de modèles		Sécurité	
Modellnummernlegende		Sicherheit	
Identificación de número de modelo		Seguridad	
Configuratore del numero del modello		Sicurezza	
Retainer Rings	6	Lifetime Warranty	24
Anneaux de retenue		Douilles garanties à vie	
Sprengringe (Ret-Ringe)		Lebenslange Garantie	
Anillos de retención		Garantía de por vida	
Anelli di fissaggio		Garanzia a vita	
1/4" Drive	7	Accessories	24
Entraîneur de 1/4"		Accessoires	
1/4-Zoll-Antrieb		Zubehör	
Llave de 1/4"		Accesorios	
Attacco da 1/4"		Accessori	
3/8" Drive	9		
Entraîneur de 3/8"			
3/8-Zoll-Antrieb			
Llave de 3/8"			
Attacco da 3/8"			

*Ne vous laissez pas tromper par les apparences !
Lassen Sie sich von dem guten Aussehen nicht täuschen...
No deje que las apariencias le engañen...
Non fatevi ingannare da un bell'aspetto...*

Don't Let The Good Looks Fool You...

Backed by an extensive heritage of reliability and innovation, Ingersoll Rand introduces a comprehensive line of industrial-grade sockets that really make an impact

- Impact-grade strength and durability you expect from a global leader
- Sleek, new look for industrial products that look better than ever before
- Nearly 800 impact socket items for virtually any assembly or disassembly job

From air compressors to impact tools to impact sockets (and everything in between), Ingersoll Rand provides the toughest, highest quality products available.

En se fondant sur un long héritage de fiabilité et d'innovation, Ingersoll Rand a développé une ligne complète de douilles de qualité industrielle qui garantissent des résultats satisfaisants.

- La résistance à toute épreuve et la durabilité auxquelles vous vous attendez de la part d'un fournisseur à la pointe du marché mondial
- Des produits industriels élégants, d'un style nouveau, avec une apparence plus attractive que jamais
- Environ 800 douilles à choc qui offrent une solution pour pratiquement toutes les tâches de montage ou de démontage

Des compresseurs à air aux douilles à choc, en passant par les outils de choc et divers autres types d'outils, Ingersoll Rand offre les produits les plus robustes et de la meilleure qualité disponibles sur le marché.

Ingersoll Rand, bekannt für hohe Zuverlässigkeit und Innovation, stellt eine umfassende Produktreihe hochwertiger Steckschlüsseleinsätze vor, die ihre Wirkung nicht verfehlen.

- Schlagfestigkeit und Leistung, die Sie von einem weltweit führenden Hersteller erwarten.
- Elegantes und innovatives Design für Industrierwerkzeuge, die besser als je zuvor aussehen.
- Fast 800 Steckschlüsseleinsätze für praktisch jede Montage- und Demontageanwendung.

Angefangen bei Luftkompressoren über Schlagwerkzeuge bis hin zu Steckschlüsseleinsätzen – Ingersoll-Rand liefert die robustesten und hochwertigsten Produkte auf dem Markt.

Respaldada por una amplia trayectoria de fiabilidad e innovación, Ingersoll Rand presenta una completa línea de bocas de gama industrial que realmente producen un gran impacto.

- La resistencia y durabilidad en el impacto que usted espera de un líder mundial
- Nuevo e impecable aspecto para productos industriales que más atractivos que nunca
- Aproximadamente 800 bocas para llaves de impacto para prácticamente cualquier trabajo de ensamblaje o desmontaje

Desde compresores de aire hasta herramientas de impacto y bocas para llaves de impacto (y todo lo que esto comprende), Ingersoll Rand ofrece los productos más resistentes con la mejor calidad del mercado.

Con alle spalle una lunga storia di affidabilità e innovazione, la Ingersoll Rand presenta una linea completa di chiavi a bussola industriali che colpiscono veramente.

- La resistenza agli impatti e la durata che ci si aspetta da un leader mondiale
- Prodotti industriali di aspetto nuovo ed elegante, mai così belli
- Circa 800 bussole serie Impact, per praticamente qualsiasi lavoro di smontaggio e rimontaggio

Dai compressori d'aria agli utensili pneumatici, alle bussole Impact (con una gamma di prodotti davvero completa), la Ingersoll Rand offre i prodotti più robusti e di migliore qualità disponibili sul mercato.





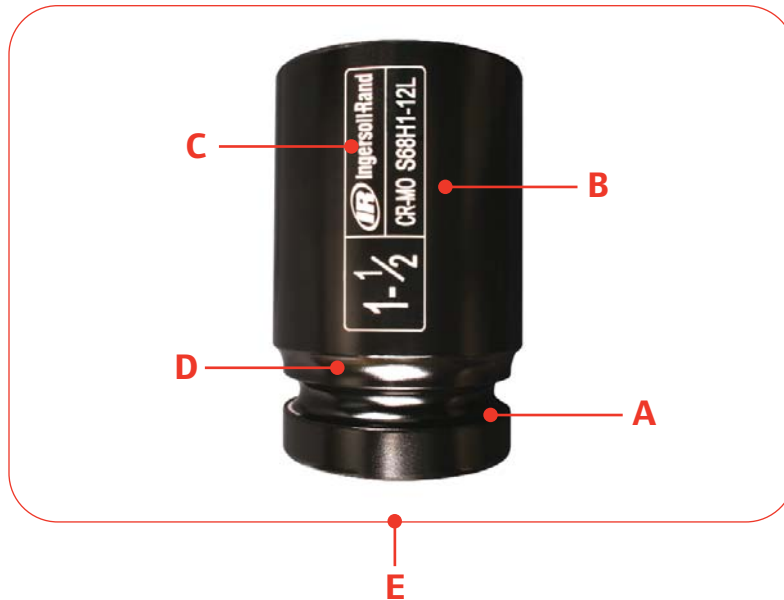

















Features & Benefits



Features	Benefits
A Impact-grade toughness Robustesse à toute épreuve Schlagsichere Robustheit Resistencia contra impacto Alta resistenza agli impatti	Designed for high torque applications Conçues pour les applications à couple élevé Für Anwendungen mit hohen Drehmomenten Diseñadas para aplicaciones con pares altos Progettate per resistere a coppie elevate
B Chrome-molybdenum steel Acier au chrome-molybdène Chrom-Molybdän-Stahl Acero al cromo-molibdeno Acciaio al cromo-molibdeno	Forged for high-strength durability Forgées pour garantir la durabilité de la résistance Für eine überzeugende Leistungsfähigkeit Forjadas para una durabilidad de gran resistencia Forgiate per alta resistenza
C Laser-etched size labeling Taille gravée au laser Laser-Größenangabe Tamaño grabado con láser Indicazioni della misura incise a laser	Enables easier identification to get the job done faster Permet une identification plus aisée qui accélère l'exécution des tâches Für eine einfache Kennzeichnung und schnellere Erledigung des Auftrags Facilita la identificación para una mayor rapidez en los trabajos Identificazione più facile per lavorare più rapidamente
D Electro-phosphate finish Finition électro-phosphatique Elektrophosphat-Finish Acabado de electrofosfato Finitura fosfatata	Projects a sleeker look for higher visibility Possèdent une apparence plus élégante qui les rend plus visibles Für ein ansprechenderes Äußeres und gute Sichtbarkeit De un aspecto más reluciente para una mayor visibilidad Aspetto più svelto per migliore visibilità
E Backed by a Lifetime Warranty Couvertes par une garantie à vie Lebenslange Garantie Con garantía de por vida Garantite a vita	Provides peace of mind with proven reliability Garantissent la tranquillité d'esprit grâce à leur fiabilité éprouvée Für eine sorgenfreie Anwendung und bewährte Zuverlässigkeit Proporciona tranquilidad con una fiabilidad probada Danno la massima sicurezza grazie alla provata affidabilità

Sockets Product Information

Présentation de la gamme
Steckschlüssel Produktinformation
Información de Bocas
Informazioni sulle bussole

Description / Socket square drive Description / Dimension carré entraîneur Beschreibung / Antriebsvierkant Descripción / Cuadradillo Descrizione / Attacco quadro		1/4"	3/8"	1/2"	3/4"	1"
6 point, standard length – Metric & SAE 6 pans, longueur std – Métriques & SAE 6 Punkt – Standardlänge – Metrisch & SAE 6 caras, longitud estándar, métricas y SAE Esagonale, lungh. standard, metriche e SAE						
6 point, deep length – Metric & SAE 6 pans, profondes – Métriques & SAE 6 Punkt – Lang – Metrisch und SAE 6 caras, larga, métricas y SAE Esagonale, lungh. maggiore, metriche e SAE						
6 point, Universal, standard length – Metric & SAE 6 pans, Universel, longueur std – Métriques & SAE 6 Punkt – Universal – Standardlänge – Metrisch & SAE 6 caras, Universal, longitud estándar, métricas y SAE Esagonale, Universale, lungh. standard, metriche e SAE						
6 point, Universal, deep length – Metric & SAE 6 pans, Universel, profondes – Métriques & SAE 6 Punkt – Universal – Lang – Metrisch & SAE 6 caras, Universal, larga, métricas y SAE Esagonale, Universale, lungh. maggiore, metriche e SAE						

Lifetime Warranty on all sockets from manufacturing and material defects.

Douilles garanties à vie contre tout défaut de fabrication ou de matière.

Lebenslange Garantie auf alle Hochleistungs-Steckschlüsseleinsätze in Bezug auf Herstellungs- und Materialfehler.

Garantía de por vida para todas las bocas en defectos de material y de fabricación.

Garanzia a vita su tutti gli inserti per difetti di produzione e materiale.



Model Number Configurator

S64H78U

SK3M8L

Single Item

S	6	4	H	78	U
Socket Type	Output Type	Drive Size	SAE or Metric	Across Flats	Socket Length
A= Adapter E= Extension J= Universal Joint S= Socket	12= 12 point 6= 6 point	2= 1/4" 3= 3/8" 4= 1/2" 6= 3/4" 8= 1"	H= SAE M= Metric	SAE socket: i.e. 38= 3/8" (from 7/32" to 4 1/2") Metric socket: i.e. 20 (from 4mm to 125mm) Extensions: i.e. 3" (from 2" to 36")	L= Deep U= Universal UL= Universal Deep

Socket Sets

S	K	3	M	8	L
Socket Type	Kit	Drive Size	SAE or Metric	Number of pieces per kit	Socket Length
S= Socket	K= Kit	2= 1/4" 3= 3/8" 4= 1/2" 34= Combo 3/8" & 1/2" 6= 3/4" 8= 1"	H= SAE M= Metric C= Combo SAE & Metric	3= 3 pieces 4= 4 pieces 5= 5 pieces 7= 7 pieces 8= 8 pieces 9= 9 pieces 10= 10 pieces 13= 13 pieces 14= 14 pieces 86= 86 pieces	L= Deep F= Flip U= Universal

Ret-Ring™

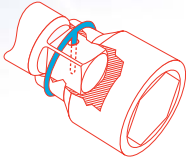

Socket retainer rings

Anneaux de retenue de douilles

Ret-Ring™ mit Stahleinsatz

Anillos retenedores de bocas

Anelli di ritenuta bussola



Reference	aQuantity Quantité Menge (VPE) Cantidad Quantità	Internal Ø (mm) Ø intérieur (mm) Innen-Ø (mm) Ø interior (mm) Ø interno (mm)	Material Matière Material Material Materiale
RR10001	10	15.0	Plastic
RR10002	10	17.0	Plastic
RR10003	10	19.0	Plastic
RR10004	10	20.0	Plastic
RR10005	10	22.0	Plastic
RR10006	10	24.0	Plastic
RR10007	10	24.0	Plastic
RR10008	10	29.0	Plastic
RR10005S	1	32.0	Plastic + Steel insert
RR10009	10	33.0	Plastic
RR10032S	1	36.5	Plastic + Steel insert
RR10010	10	37.0	Plastic
RR10034S	1	41.5	Plastic + Steel insert
RR10008S	1	44.5	Plastic + Steel insert
RR10010S	1	49.0	Plastic + Steel insert
RR10015S	1	54-57	Plastic + Steel insert
RR10017S	1	63.5	Plastic + Steel insert
RR10019S	1	67.0	Plastic + Steel insert
RR10020S	1	76.0	Plastic + Steel insert
RR10025S	1	86.0	Plastic + Steel insert
RR10030S	1	98.5	Plastic + Steel insert
RR10035S	1	111.0	Plastic + Steel insert

Because of the elasticity of the material, the diameter at the female square drive of the socket (D2) can be slightly larger than the ring. Note: The retainer rings must have a tight fit on the socket.

Du fait de l'élasticité du matériau, le diamètre du côté carré entraîneur de la douille (D2) peut être un peu plus large que l'anneau. Nota: L'anneau de retenue doit être serré sur la douille.

Aufgrund der Elastizität des Materials kann der Durchmesser am Antriebsvierkant des Steckschlüssels (D2) nach oben hin etwas abweichen. Es ist auf festen Sitz des Ret-Ring's auf dem Steckschlüssel-Einsatz zu achten.

Debido a la elasticidad del material, el diámetro en el cuadradillo hembra de la boca (D2) puede ser ligeramente más grande que el anillo. N.B. El anillo retenedor debe quedar ajustado a la boca.

A causa dell'elasticità del materiale, il diametro sulla parte dell'attacco femmina della bussola, potrebbe essere leggermente più grande. N.B. L'anello di ritenuta deve essere aderente alla bussola.

1/4" square drive sockets
 Douilles pour entraineur 1/4"
 1/4" Vierkant Steckschlüssel
 Bocas de cuadrado 1/4"
 Bussole con attacco da 1/4"

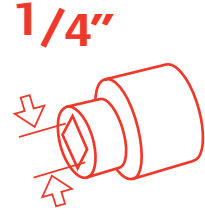

1/4"
Drive



Part #	Output Size	Type	D1 in (mm)	D2 in (mm)	T in (mm)	L in (mm)
SAE (in)						
S62H316	3/16	A	0.33 (8.5)	0.51 (13)	0.19 (5)	0.90 (23)
S62H732	7/32	A	0.37 (9.5)	0.51 (13)	0.19 (5)	0.90 (23)
S62H14	1/4	A	0.40 (10.3)	0.51 (13)	0.19 (5)	0.90 (23)
S62H932	9/32	A	0.44 (11.3)	0.51 (13)	0.27 (7)	0.90 (23)
S62H516	5/16	A	0.49 (12.5)	0.51 (13)	0.27 (7)	0.90 (23)
S62H1132	11/32	B	0.55 (14)	0.55 (14)	0.27 (7)	0.90 (23)
S62H38	3/8	B	0.63 (16)	0.63 (16)	0.31 (8)	0.90 (23)
S62H716	7/16	B	0.66 (17)	0.66 (17)	0.31 (8)	0.90 (23)
S62H12	1/2	B	0.74 (19)	0.74 (19)	0.31 (8)	0.90 (23)
S62H916	9/16	B	0.78 (20)	0.78 (20)	0.31 (8)	0.90 (23)
Metric (mm)						
S62M4	4	A	0.29 (7.6)	0.51 (13)	0.19 (5)	0.90 (23)
S62M45	4.5	A	0.32 (8.2)	0.51 (13)	0.19 (5)	0.90 (23)
S62M5	5	A	0.346 (8.8)	0.51 (13)	0.19 (5)	0.90 (23)
S62M55	5.5	A	0.37 (9.5)	0.51 (13)	0.19 (5)	0.90 (23)
S62M6	6	A	0.39 (10)	0.51 (13)	0.27 (7)	0.90 (23)
S62M7	7	A	0.44 (11.3)	0.51 (13)	0.27 (7)	0.90 (23)
S62M8	8	A	0.49 (12.5)	0.51 (13)	0.27 (7)	0.90 (23)
S62M9	9	B	0.55 (14)	0.55 (14)	0.27 (7)	0.90 (23)
S62M10	10	B	0.57 (14.5)	0.57 (14.5)	0.27 (7)	0.90 (23)
S62M11	11	B	0.66 (17)	0.66 (17)	0.31 (8)	0.90 (23)
S62M12	12	B	0.70 (18)	0.70 (18)	0.31 (8)	0.90 (23)
S62M13	13	B	0.74 (19)	0.74 (19)	0.31 (8)	0.90 (23)
S62M14	14	B	0.78 (20)	0.78 (20)	0.31 (8)	0.90 (23)
S62M15	15	B	0.82 (21)	0.82 (21)	0.31 (8)	0.90 (23)



Part #	Output Size	Type	D1 in (mm)	D2 in (mm)	T in (mm)	L in (mm)
SAE (in)						
S62H316L	3/16	A	0.33 (8.5)	0.51 (13)	0.19 (5)	1.96 (50)
S62H732L	7/32	A	0.37 (9.5)	0.51 (13)	0.19 (5)	1.96 (50)
S62H14L	1/4	A	0.40 (10.3)	0.51 (13)	0.19 (5)	1.96 (50)
S62H932L	9/32	A	0.44 (11.3)	0.51 (13)	0.27 (7)	1.96 (50)
S62H516L	5/16	A	0.49 (12.5)	0.51 (13)	0.27 (7)	1.96 (50)
S62H1132L	11/32	B	0.55 (14)	0.55 (14)	0.27 (7)	1.96 (50)
S62H38L	3/8	B	0.63 (16)	0.63 (16)	0.31 (8)	1.96 (50)
S62H716L	7/16	B	0.66 (17)	0.66 (17)	0.31 (8)	1.96 (50)
S62H12L	1/2	B	0.74 (19)	0.74 (19)	0.31 (8)	1.96 (50)
S62H916L	9/16	B	0.78 (20)	0.78 (20)	0.31 (8)	1.96 (50)
Metric (mm)						
S62M4L	4	A	0.29 (7.6)	0.51 (13)	0.19 (5)	1.96 (50)
S62M45L	4.5	A	0.32 (8.2)	0.51 (13)	0.19 (5)	1.96 (50)
S62M5L	5	A	0.34 (8.8)	0.51 (13)	0.19 (5)	1.96 (50)
S62M55L	5.5	A	0.37 (9.5)	0.51 (13)	0.19 (5)	1.96 (50)
S62M6L	6	A	0.39 (10)	0.51 (13)	0.27 (7)	1.96 (50)
S62M7L	7	A	0.44 (11.3)	0.51 (13)	0.27 (7)	1.96 (50)
S62M8L	8	A	0.49 (12.5)	0.51 (13)	0.27 (7)	1.96 (50)
S62M9L	9	B	0.57 (14.5)	0.57 (14.5)	0.27 (7)	1.96 (50)
S62M10L	10	B	0.63 (16)	0.63 (16)	0.27 (7)	1.96 (50)
S62M11L	11	B	0.66 (17)	0.66 (17)	0.31 (8)	1.96 (50)
S62M12L	12	B	0.66 (17)	0.66 (17)	0.31 (8)	1.96 (50)
S62M13L	13	B	0.74 (19)	0.74 (19)	0.31 (8)	1.96 (50)
S62M14L	14	B	0.78 (20)	0.78 (20)	0.31 (8)	1.96 (50)
S62M15L	15	B	0.82 (21)	0.82 (21)	0.31 (8)	1.96 (50)

Sets

Part #	# of pieces	Description	Contents
SK2C10	10	1/4" Drive Combo SAE & Metric Standard Socket Set	3/16", 1/4", 3/8", 1/2", 9/16", 4mm, 6mm, 10mm, 12mm, 14mm



SK2C10

1/4"

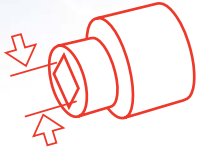

1/4" square drive sockets

Douilles pour entraîneur 1/4"
 1/4" Vierkant Steckschlüssel
 Bocas de cuadradillo 1/4"
 Bussole con attacco da 1/4"

1/4"
 Drive

Part #	Output Size	Type	D1 in (mm)	D2 in (mm)	T in (mm)	L in (mm)
Universal						
SAE (in)						
S62H14U	1/4	A	0.47 (12)	0.63 (16)	0.23 (6)	1.73 (44)
S62H516U	5/16	A	0.51 (13)	0.63 (16)	0.23 (6)	1.73 (44)
S62H38U	3/8	A	0.63 (16)	0.63 (16)	0.31 (8)	1.73 (44)
S62H716U	7/16	A	0.66 (17)	0.63 (16)	0.31 (8)	1.73 (44)
S62H12U	1/2	A	0.74 (19)	0.63 (16)	0.31 (8)	1.89 (48)
S62H916U	9/16	A	0.78 (20)	0.63 (16)	0.31 (8)	1.89 (48)
Metric (mm)						
S62M5U	5	A	0.47 (12)	0.63 (16)	0.23 (6)	1.73 (44)
S62M55U	5.5	A	0.47 (12)	0.70 (18)	0.23 (6)	1.73 (44)
S62M6U	6	A	0.47 (12)	0.70 (18)	0.23 (6)	1.73 (44)
S62M7U	7	A	0.47 (12)	0.70 (18)	0.23 (6)	1.73 (44)
S62M8U	8	A	0.51 (13)	0.70 (18)	0.31 (8)	1.73 (44)
S62M9U	9	A	0.59 (15)	0.70 (18)	0.31 (8)	1.73 (44)
S62M10U	10	A	0.63 (16)	0.70 (18)	0.31 (8)	1.73 (44)
S62M11U	11	A	0.66 (17)	0.70 (18)	0.31 (8)	1.73 (44)
S62M12U	12	A	0.66 (17)	0.70 (18)	0.31 (8)	1.89 (48)
S62M13U	13	A	0.74 (19)	0.70 (18)	0.31 (8)	1.89 (48)
S62M14U	14	A	0.78 (20)	0.70 (18)	0.31 (8)	1.89 (48)
S62M15U	15	A	0.82 (21)	0.70 (18)	0.31 (8)	1.89 (48)

Part #	Output Drive Size	Description
Adapters*		
A2F3M	3/8	1/4" F to 3/8" M
J2	1/4	Universal Joint

Part #	Output Drive Size	Description
Extensions		
E22H	1/4	2" Extension
E24H	1/4	4" Extension
E26H	1/4	6" Extension

* Reducing Adapters are not covered under the Lifetime Warranty.

3/8" square drive sockets
 Douilles pour entraineur 3/8"
 3/8" Vierkant Steckschlüssel
 Bocas de cuadrado 3/8"
 Bussole con attacco da 3/8"

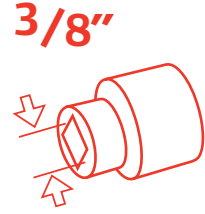

3/8"
Drive

Sets

Part #	# of pieces	Description	Contents
SK3H8	8	3/8" Drive SAE Standard Socket Set	5/16", 3/8", 7/16", 1/2", 9/16", 5/8", 11/16", 3/4"
SK3H8L	8	3/8" Drive SAE Deep Socket Set	5/16", 3/8", 7/16", 1/2", 9/16", 5/8", 11/16", 3/4"
SK3H7U	7	3/8" Drive SAE Universal Socket Set	3/8", 7/16", 1/2", 9/16", 5/8", 11/16", 3/4"
SK3M8	8	3/8" Drive Metric Standard Socket Set	9mm, 10mm, 11mm, 13mm, 14mm, 15mm, 17mm, 19mm
SK3M8L	8	3/8" Drive Metric Deep Socket Set	9mm, 10mm, 11mm, 13mm, 14mm, 15mm, 17mm, 19mm
SK3M7U	7	3/8" Drive Metric Universal Socket Set	10mm, 12mm, 13mm, 14mm, 15mm, 17mm, 19mm
SK3C8	8	3/8" Drive Combo SAE & Metric Standard Socket Set	3/8", 1/2", 5/8", 11/16", 10mm, 13mm, 16mm, 17mm



SK3H8



SK3H8L



SK3H7U



SK3M8



SK3M8L



SK3M7U



SK3C8

3/8"

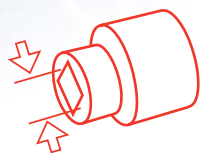

3/8" square drive sockets

Douilles pour entraîneur 3/8"

3/8" Vierkant Steckschlüssel

Bocas de cuadrado 3/8"

Bussole con attacco da 3/8"



Standard

Part #	Output Size	Type	D1 in (mm)	D2 in (mm)	T in (mm)	L in (mm)
SAE (in)						
S63H14	1/4	A	0.43 (11)	0.74 (19)	0.15 (4)	1.10 (28)
S63H516	5/16	A	0.49 (12.5)	0.74 (19)	0.27 (7)	1.10 (28)
S63H38	3/8	A	0.57 (14.5)	0.74 (19)	0.27 (7)	1.10 (28)
S63H716	7/16	A	0.66 (17)	0.74 (19)	0.27 (7)	1.18 (30)
S63H12	1/2	B	0.74 (19)	0.74 (19)	0.27 (7)	1.18 (30)
S63H916	9/16	B	0.78 (20)	0.78 (20)	0.27 (7)	1.18 (30)
S63H58	5/8	B	0.94 (24)	0.94 (24)	0.39 (10)	1.18 (30)
S63H1116	11/16	B	0.94 (24)	0.94 (24)	0.39 (10)	1.26 (32)
S63H34	3/4	B	1.02 (26)	1.02 (26)	0.39 (10)	1.26 (32)
S63H1316	13/16	B	1.18 (30)	1.18 (30)	0.51 (13)	1.26 (32)
S63H78	7/8	B	1.26 (32)	1.26 (32)	0.51 (13)	1.26 (32)
S63H1516	15/16	B	1.33 (34)	1.33 (34)	0.51 (13)	1.26 (32)
S63H1	1	B	1.33 (34)	1.33 (34)	0.51 (13)	1.26 (32)
Metric (mm)						
S63M6	6	A	0.41 (10.5)	0.74 (19)	0.15 (4)	1.10 (28)
S63M7	7	A	0.45 (11.5)	0.74 (19)	0.27 (7)	1.10 (28)
S63M8	8	A	0.49 (12.5)	0.74 (19)	0.27 (7)	1.10 (28)
S63M9	9	A	0.55 (14)	0.74 (19)	0.27 (7)	1.10 (28)
S63M10	10	A	0.59 (15)	0.74 (19)	0.27 (7)	1.10 (28)
S63M11	11	A	0.66 (17)	0.74 (19)	0.27 (7)	1.18 (30)
S63M12	12	B	0.70 (18)	0.74 (19)	0.27 (7)	1.18 (30)
S63M13	13	B	0.74 (19)	0.74 (19)	0.27 (7)	1.18 (30)
S63M14	14	B	0.78 (20)	0.78 (20)	0.27 (7)	1.18 (30)
S63M15	15	B	0.86 (22)	0.86 (22)	0.39 (10)	1.18 (30)
S63M16	16	B	0.94 (24)	0.94 (24)	0.39 (10)	1.18 (30)
S63M17	17	B	0.94 (24)	0.94 (24)	0.39 (10)	1.26 (32)
S63M18	18	B	1.02 (26)	1.02 (26)	0.51 (13)	1.26 (32)
S63M19	19	B	1.02 (26)	1.02 (26)	0.51 (13)	1.26 (32)
S63M20	20	B	1.10 (28)	1.10 (28)	0.51 (13)	1.26 (32)
S63M21	21	B	1.18 (30)	1.18 (30)	0.51 (13)	1.26 (32)
S63M22	22	B	1.26 (32)	1.26 (32)	0.51 (13)	1.26 (32)



Deep

Part #	Output Size	Type	D1 in (mm)	D2 in (mm)	T in (mm)	L in (mm)
SAE (in)						
S63H516L	5/16	A	0.49 (12.5)	0.74 (19)	0.47 (12)	2.48 (63)
S63H38L	3/8	A	0.57 (14.5)	0.74 (19)	0.55 (14)	2.48 (63)
S63H716L	7/16	A	0.66 (17)	0.74 (19)	0.66 (17)	2.48 (63)
S63H12L	1/2	B	0.74 (19)	0.74 (19)	0.66 (17)	2.48 (63)
S63H916L	9/16	B	0.78 (20)	0.78 (20)	0.66 (17)	2.48 (63)
S63H58L	5/8	B	0.94 (24)	0.94 (24)	0.66 (17)	2.48 (63)
S63H1116L	11/16	B	0.94 (24)	0.94 (24)	0.66 (17)	2.48 (63)
S63H34L	3/4	B	1.02 (26)	1.02 (26)	0.74 (19)	2.48 (63)
S63H1316L	13/16	B	1.18 (30)	1.18 (30)	0.74 (19)	2.48 (63)
S63H78L	7/8	B	1.26 (32)	1.26 (32)	0.74 (19)	2.48 (63)
S63H1516L	15/16	B	1.33 (34)	1.33 (34)	0.82 (21)	2.48 (63)
S63H1L	1	B	1.41 (36)	1.41 (36)	0.82 (21)	2.48 (63)
Metric (mm)						
S63M7L	7	A	0.45 (11.5)	0.74 (19)	0.43 (11)	2.48 (63)
S63M8L	8	A	0.49 (12.5)	0.74 (19)	0.47 (12)	2.48 (63)
S63M9L	9	A	0.55 (14)	0.74 (19)	0.55 (14)	2.48 (63)
S63M10L	10	A	0.59 (15)	0.74 (19)	0.55 (14)	2.48 (63)
S63M11L	11	A	0.66 (17)	0.74 (19)	0.66 (17)	2.48 (63)
S63M12L	12	B	0.70 (18)	0.74 (19)	0.66 (17)	2.48 (63)
S63M13L	13	B	0.74 (19)	0.74 (19)	0.66 (17)	2.48 (63)
S63M14L	14	B	0.78 (20)	0.78 (20)	0.66 (17)	2.48 (63)
S63M15L	15	B	0.86 (22)	0.86 (22)	0.74 (19)	2.48 (63)
S63M16L	16	B	0.94 (24)	0.94 (24)	0.74 (19)	2.48 (63)
S63M17L	17	B	0.94 (24)	0.94 (24)	0.74 (19)	2.48 (63)
S63M18L	18	B	1.02 (26)	1.02 (26)	0.74 (19)	2.48 (63)
S63M19L	19	B	1.02 (26)	1.02 (26)	0.82 (21)	2.48 (63)
S63M20L	20	B	1.10 (28)	1.10 (28)	0.82 (21)	2.48 (63)
S63M21L	21	B	1.18 (30)	1.18 (30)	0.82 (21)	2.48 (63)
S63M22L	22	B	1.26 (32)	1.26 (32)	0.82 (21)	2.48 (63)

3/8" square drive sockets
 Douilles pour entraineur 3/8"
 3/8" Vierkant Steckschlüssel
 Bocas de cuadradillo 3/8"
 Bussole con attacco da 3/8"

3/8"

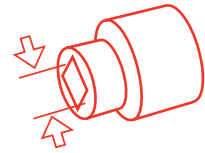

Universal

Part #	Output Size	Type	D1 in (mm)	D2 in (mm)	T in (mm)	L in (mm)
SAE (in)						
S63H516U	5/16	A	0.68 (17.5)	0.94 (24)	0.47 (12)	2.08 (53)
S63H38U	3/8	A	0.59 (15)	0.94 (24)	0.47 (12)	2.08 (53)
S63H716U	7/16	A	0.72 (18.5)	0.94 (24)	0.47 (12)	2.08 (53)
S63H12U	1/2	A	0.74 (19)	0.94 (24)	0.47 (12)	2.08 (53)
S63H916U	9/16	A	0.86 (22)	0.94 (24)	0.47 (12)	2.08 (53)
S63H58U	5/8	A	0.94 (24)	0.94 (24)	0.47 (12)	2.08 (53)
S63H1116U	11/16	A	0.98 (25)	0.94 (24)	0.47 (12)	2.08 (53)
S63H34U	3/4	A	1.10 (28)	0.94 (24)	0.47 (12)	2.08 (53)
S63H1316U	13/16	A	1.26 (32)	0.94 (24)	0.47 (12)	2.08 (53)
S63H78U	7/8	A	1.26 (32)	0.94 (24)	0.47 (12)	2.08 (53)
S63H1516U	15/16	A	1.33 (34)	0.94 (24)	0.47 (12)	2.08 (53)
S63H1U	1	A	1.41 (36)	0.94 (24)	0.47 (12)	2.08 (53)
Metric (mm)						
S63M8U	8	A	0.68 (17.5)	0.94 (24)	0.47 (12)	2.08 (53)
S63M9U	9	A	0.68 (17.5)	0.94 (24)	0.47 (12)	2.08 (53)
S63M10U	10	A	0.65 (16.5)	0.94 (24)	0.47 (12)	2.08 (53)
S63M11U	11	A	0.74 (19)	0.94 (24)	0.47 (12)	2.08 (53)
S63M12U	12	A	0.74 (19)	0.94 (24)	0.47 (12)	2.08 (53)
S63M13U	13	A	0.78 (20)	0.94 (24)	0.47 (12)	2.08 (53)
S63M14U	14	A	0.86 (22)	0.94 (24)	0.47 (12)	2.08 (53)
S63M15U	15	A	0.86 (22)	0.94 (24)	0.47 (12)	2.08 (53)
S63M16U	16	A	1.02 (26)	0.94 (24)	0.47 (12)	2.08 (53)
S63M17U	17	A	1.02 (26)	0.94 (24)	0.47 (12)	2.08 (53)
S63M18U	18	A	1.02 (26)	0.94 (24)	0.47 (12)	2.08 (53)
S63M19U	19	A	1.10 (28)	0.94 (24)	0.47 (12)	2.08 (53)
S63M20U	20	A	1.26 (32)	0.94 (24)	0.47 (12)	2.08 (53)
S63M21U	21	A	1.26 (32)	0.94 (24)	0.47 (12)	2.08 (53)
S63M22U	22	A	1.26 (32)	0.94 (24)	0.47 (12)	2.08 (53)



Deep Universal

Part #	Output Size	Type	D1 in (mm)	D2 in (mm)	T in (mm)	L in (mm)
SAE (in)						
S63H516UL	5/16	A	0.68 (17.5)	0.94 (24)	0.51 (13)	3.03 (77)
S63H38UL	3/8	A	0.70 (18)	0.94 (24)	0.51 (13)	3.03 (77)
S63H716UL	7/16	A	0.70 (18)	0.94 (24)	0.51 (13)	3.03 (77)
S63H12UL	1/2	A	0.74 (19)	0.94 (24)	0.51 (13)	3.03 (77)
S63H916UL	9/16	A	0.82 (21)	0.94 (24)	0.51 (13)	3.03 (77)
S63H58UL	5/8	A	0.90 (23)	0.94 (24)	0.51 (13)	3.03 (77)
S63H1116UL	11/16	A	0.98 (25)	0.94 (24)	0.51 (13)	3.03 (77)
S63H34UL	3/4	A	1.06 (27)	0.94 (24)	0.51 (13)	3.03 (77)
S63H1316UL	13/16	A	1.18 (30)	0.94 (24)	0.51 (13)	3.03 (77)
S63H78UL	7/8	A	1.26 (32)	0.94 (24)	0.51 (13)	3.03 (77)
Metric (mm)						
S63M8UL	8	A	0.68 (17.5)	0.94 (24)	0.51 (13)	3.03 (77)
S63M9UL	9	A	0.68 (17.5)	0.94 (24)	0.51 (13)	3.03 (77)
S63M10UL	10	A	0.70 (18)	0.94 (24)	0.51 (13)	3.03 (77)
S63M11UL	11	A	0.70 (18)	0.94 (24)	0.51 (13)	3.03 (77)
S63M12UL	12	A	0.74 (19)	0.94 (24)	0.51 (13)	3.03 (77)
S63M13UL	13	A	0.74 (19)	0.94 (24)	0.51 (13)	3.03 (77)
S63M14UL	14	A	0.82 (21)	0.94 (24)	0.51 (13)	3.03 (77)
S63M15UL	15	A	0.86 (22)	0.94 (24)	0.51 (13)	3.03 (77)
S63M16UL	16	A	1.02 (26)	0.94 (24)	0.51 (13)	3.03 (77)
S63M17UL	17	A	0.98 (25)	0.94 (24)	0.51 (13)	3.03 (77)
S63M18UL	18	A	1.02 (26)	0.94 (24)	0.51 (13)	3.03 (77)
S63M19UL	19	A	1.06 (27)	0.94 (24)	0.51 (13)	3.03 (77)
S63M20UL	20	A	1.10 (28)	0.94 (24)	0.51 (13)	3.03 (77)
S63M21UL	21	A	1.18 (30)	0.94 (24)	0.51 (13)	3.03 (77)
S63M22UL	22	A	1.26 (32)	0.94 (24)	0.51 (13)	3.03 (77)



Adapters*

Part #	Output Drive Size	Description
A3F2M	1/4	3/8" F to 1/4" M
A3F4M	1/2	3/8" F to 1/2" M
J3	3/8	Universal Joint



Extensions

Part #	Output Drive Size	Description
E33H	3/8	3" Extension
E36H	3/8	6" Extension
E312H	3/8	12" Extension

1/2"

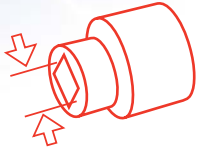

1/2" square drive sockets
 Douilles pour entraîneur 1/2"
 1/2" Vierkant Steckschlüssel
 Bocas de cuadradillo 1/2"
 Bussole con attacco da 1/2"

Sets

Part #	# of pieces	Description	Contents
SK4H13	13	1/2" Drive SAE Standard Socket Set	7/16", 1/2", 9/16", 5/8", 11/16", 3/4", 13/16", 7/8", 15/16", 1", 1-1/16", 1-1/8", 1-1/4"
SK4H13L	13	1/2" Drive SAE Deep Socket Set	7/16", 1/2", 9/16", 5/8", 11/16", 3/4", 13/16", 7/8", 15/16", 1", 1-1/16", 1-1/8", 1-1/4"
SK4H7U	7	1/2" Drive SAE Universal Socket Set	1/2", 9/16", 5/8", 11/16", 3/4", 13/16", 7/8"
SK4M14	14	1/2" Drive Metric Standard Socket Set	10mm, 11mm, 12mm, 13mm, 14mm, 15mm, 16mm, 17mm, 18mm, 19mm, 21mm, 22mm, 26mm, 27mm
SK4M14L	14	1/2" Drive Metric Deep Socket Set	10mm, 11mm, 12mm, 13mm, 14mm, 15mm, 16mm, 17mm, 18mm, 19mm, 21mm, 22mm, 26mm, 27mm
SK4M4L	4	1/2" Drive Metric Deep Axle Nut Service Socket Set	30mm, 32mm, 34mm, 36mm
SK4M7U	7	1/2" Drive Metric Universal Socket Set	13mm, 14mm, 15mm, 17mm, 19mm, 21mm, 22mm
SK4C3F	3	1/2" Drive Lugnet Service Flip Socket Set	3/4" x 3/16", 19mm x 21mm, 3" extension
SK34C86	86	3/8" & 1/2" Drive Combo Standard & Deep Socket Set	Includes all sockets in SK3H8, SK3H8L, SK3M8, SK3M8L, SK4H13, SK4H13L, SK4M14, & SK4M14L



SK4H13



SK4H13L



SK4H7U



SK4M14



SK4M14L



SK4M4L



SK4M7U



SK4C3F



SK34C86

1/2"
Drive

1/2" square drive sockets
 Douilles pour entraîneur 1/2"
 1/2" Vierkant Steckschlüssel
 Bocas de cuadrado 1/2"
 Bussole con attacco da 1/2"

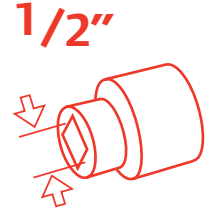

Standard

Part #	Output Size	Type	D1 in (mm)	D2 in (mm)	T in (mm)	L in (mm)
SAE (in)						
S64H516	5/16	A	0.55 (14)	0.86 (22)	0.35 (9)	1.49 (38)
S64H38	3/8	A	0.63 (16)	0.86 (22)	0.43 (11)	1.49 (38)
S64H716	7/16	A	0.70 (18)	0.86 (22)	0.43 (11)	1.49 (38)
S64H12	1/2	A	0.76 (19.5)	0.86 (22)	0.43 (11)	1.49 (38)
S64H916	9/16	A	0.84 (21.5)	0.94 (24)	0.43 (11)	1.49 (38)
S64H58	5/8	B	0.94 (24)	0.94 (24)	0.43 (11)	1.49 (38)
S64H1116	11/16	B	1.02 (26)	1.02 (26)	0.43 (11)	1.49 (38)
S64H34	3/4	B	1.10 (28)	1.10 (28)	0.63 (16)	1.57 (40)
S64H1316	13/16	B	1.18 (30)	1.18 (30)	0.63 (16)	1.57 (40)
S64H78	7/8	B	1.26 (32)	1.26 (32)	0.63 (16)	1.65 (42)
S64H1516	15/16	B	1.33 (34)	1.33 (34)	0.63 (16)	1.73 (44)
S64H1	1	B	1.41 (36)	1.41 (36)	0.70 (18)	1.73 (44)
S64H1-116	1-1/16	B	1.49 (38)	1.49 (38)	0.70 (18)	1.81 (46)
S64H1-18	1-1/8	C	1.57 (40)	1.49 (38)	0.70 (18)	1.81 (46)
S64H1-316	1-3/16	C	1.65 (42)	1.49 (38)	0.70 (18)	1.81 (46)
S64H1-14	1-1/4	C	1.73 (44)	1.49 (38)	0.78 (20)	1.81 (46)
S64H1-516	1-5/16	C	1.85 (47)	1.49 (38)	0.78 (20)	1.81 (46)
S64H1-38	1-3/8	C	1.96 (50)	1.49 (38)	0.78 (20)	1.81 (46)
S64H1-716	1-7/16	C	2.00 (51)	1.49 (38)	0.78 (20)	1.81 (46)
S64H1-12	1-1/2	C	2.08 (53)	1.49 (38)	0.86 (22)	1.81 (46)
S64H1-916	1-9/16	C	2.16 (55)	1.73 (44)	0.86 (22)	2.36 (60)
S64H1-58	1-5/8	C	2.28 (58)	1.73 (44)	0.86 (22)	2.36 (60)
S64H1-1116	1-11/16	C	2.40 (61)	1.73 (44)	0.94 (24)	2.36 (60)
S64H1-34	1-3/4	C	2.48 (63)	1.73 (44)	0.94 (24)	2.36 (60)
S64H1-1316	1-13/16	C	2.55 (65)	1.73 (44)	0.94 (24)	2.36 (60)
S64H1-78	1-7/8	C	2.59 (66)	1.73 (44)	0.94 (24)	2.36 (60)
S64H1-1516	1-15/16	C	2.67 (68)	1.73 (44)	0.94 (24)	2.36 (60)
S64H2	2	C	2.75 (70)	2.04 (52)	0.94 (24)	2.36 (60)
S64H2-116	2-1/16	C	2.83 (72)	2.04 (52)	0.94 (24)	2.36 (60)
S64H2-18	2-1/8	C	2.99 (76)	2.04 (52)	1.06 (27)	2.55 (65)
S64H2-316	2-3/16	C	3.03 (77)	2.04 (52)	1.06 (27)	2.55 (65)
S64H2-14	2-1/4	C	3.15 (80)	2.04 (52)	1.06 (27)	2.55 (65)

Part #	Output Size	Type	D1 in (mm)	D2 in (mm)	T in (mm)	L in (mm)
Metric (mm)						
S64M8	8	A	0.57 (14.5)	0.86 (22)	0.35 (9)	1.49 (38)
S64M9	9	A	0.57 (14.5)	0.86 (22)	0.43 (11)	1.49 (38)
S64M10	10	A	0.66 (17)	0.86 (22)	0.43 (11)	1.49 (38)
S64M11	11	A	0.66 (17)	0.86 (22)	0.43 (11)	1.49 (38)
S64M12	12	A	0.70 (18)	0.86 (22)	0.43 (11)	1.49 (38)
S64M13	13	A	0.78 (20)	0.86 (22)	0.43 (11)	1.49 (38)
S64M14	14	A	0.86 (22)	0.94 (24)	0.43 (11)	1.49 (38)
S64M15	15	A	0.94 (24)	0.94 (24)	0.43 (11)	1.49 (38)
S64M16	16	B	0.94 (24)	0.94 (24)	0.43 (11)	1.49 (38)
S64M17	17	B	1.02 (26)	1.02 (26)	0.43 (11)	1.49 (38)
S64M18	18	B	1.02 (26)	1.02 (26)	0.43 (11)	1.49 (38)
S64M19	19	B	1.10 (28)	1.10 (28)	0.51 (13)	1.57 (40)
S64M20	20	B	1.18 (30)	1.18 (30)	0.51 (13)	1.57 (40)
S64M21	21	B	1.18 (30)	1.18 (30)	0.51 (13)	1.57 (40)
S64M22	22	B	1.26 (32)	1.26 (32)	0.51 (13)	1.65 (42)
S64M23	23	B	1.26 (32)	1.26 (32)	0.51 (13)	1.65 (42)
S64M24	24	B	1.33 (34)	1.33 (34)	0.59 (15)	1.73 (44)
S64M25	25	B	1.37 (35)	1.37 (35)	0.59 (15)	1.73 (44)
S64M26	26	B	1.41 (36)	1.41 (36)	0.59 (15)	1.73 (44)
S64M27	27	B	1.49 (38)	1.49 (38)	0.72 (18.3)	1.81 (46)
S64M28	28	C	1.57 (40)	1.49 (38)	0.72 (18.3)	1.81 (46)
S64M29	29	C	1.57 (40)	1.49 (38)	0.72 (18.3)	1.81 (46)
S64M30	30	C	1.65 (42)	1.49 (38)	0.72 (18.3)	1.81 (46)
S64M32	32	C	1.73 (44)	1.49 (38)	0.72 (18.3)	1.81 (46)
S64M33	33	C	1.77 (45)	1.49 (38)	0.78 (20)	1.81 (46)
S64M34	34	C	1.81 (46)	1.49 (38)	0.78 (20)	1.81 (46)
S64M35	35	C	1.89 (48)	1.49 (38)	0.78 (20)	1.81 (46)
S64M36	36	C	1.96 (50)	1.49 (38)	0.78 (20)	1.96 (50)

1/2" Drive

1/2"

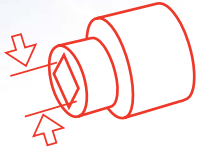

1/2" square drive sockets

Douilles pour entraîneur 1/2"

1/2" Vierkant Steckschlüssel

Bocas de cuadrado 1/2"

Bussole con attacco da 1/2"



Deep							Metric (mm)						
Part #	Output Size	Type	D1 in (mm)	D2 in (mm)	T in (mm)	L in (mm)	Part #	Output Size	Type	D1 in (mm)	D2 in (mm)	T in (mm)	L in (mm)
SAE (in)							Metric (mm)						
S64H516L	5/16	A	0.55 (14)	0.86 (22)	0.39 (10)	3.07 (78)	S64M8L	8	A	0.55 (14)	0.86 (22)	0.43 (11)	3.07 (78)
S64H38L	3/8	A	0.66 (17)	0.86 (22)	0.55 (14)	3.07 (78)	S64M9L	9	A	0.59 (15)	0.86 (22)	0.55 (14)	3.07 (78)
S64H716L	7/16	A	0.70 (18)	0.86 (22)	0.55 (14)	3.07 (78)	S64M10L	10	A	0.66 (17)	0.86 (22)	0.55 (14)	3.07 (78)
S64H12L	1/2	A	0.78 (20)	0.86 (22)	0.55 (14)	3.07 (78)	S64M11L	11	A	0.70 (18)	0.86 (22)	0.55 (14)	3.07 (78)
S64H916L	9/16	A	0.86 (22)	0.94 (24)	0.55 (14)	3.07 (78)	S64M12L	12	A	0.74 (19)	0.86 (22)	0.55 (14)	3.07 (78)
S64H58L	5/8	B	0.94 (24)	0.94 (24)	0.55 (14)	3.07 (78)	S64M13L	13	A	0.78 (20)	0.94 (24)	0.55 (14)	3.07 (78)
S64H1116L	11/16	B	1.02 (26)	1.02 (26)	0.66 (17)	3.07 (78)	S64M14L	14	A	0.86 (22)	0.94 (24)	0.74 (19)	3.07 (78)
S64H34L	3/4	B	1.10 (28)	1.10 (28)	0.66 (17)	3.07 (78)	S64M15L	15	A	0.94 (24)	0.94 (24)	0.74 (19)	3.07 (78)
S64H1316L	13/16	B	1.18 (30)	1.18 (30)	0.66 (17)	3.07 (78)	S64M16L	16	B	0.94 (24)	0.94 (24)	0.74 (19)	3.07 (78)
S64H78L	7/8	B	1.26 (32)	1.26 (32)	0.74 (19)	3.07 (78)	S64M17L	17	B	1.02 (26)	1.02 (26)	0.74 (19)	3.07 (78)
S64H1516L	15/16	B	1.33 (34)	1.33 (34)	0.74 (19)	3.07 (78)	S64M18L	18	B	1.02 (26)	1.02 (26)	0.74 (19)	3.07 (78)
S64H1L	1	B	1.41 (36)	1.41 (36)	0.74 (19)	3.07 (78)	S64M19L	19	B	1.10 (28)	1.10 (28)	0.74 (19)	3.07 (78)
S64H1-116L	1-1/16	B	1.49 (38)	1.49 (38)	0.74 (19)	3.07 (78)	S64M20L	20	B	1.18 (30)	1.18 (30)	0.74 (19)	3.07 (78)
S64H1-18L	1-1/8	C	1.57 (40)	1.49 (38)	0.74 (19)	3.07 (78)	S64M21L	21	B	1.18 (30)	1.18 (30)	0.82 (21)	3.07 (78)
S64H1-316L	1-3/16	C	1.65 (42)	1.49 (38)	0.74 (19)	3.07 (78)	S64M22L	22	B	1.26 (32)	1.26 (32)	0.82 (21)	3.07 (78)
S64H1-14L	1-1/4	C	1.73 (44)	1.49 (38)	1.18 (30)	3.07 (78)	S64M23L	23	B	1.26 (32)	1.26 (32)	0.82 (21)	3.07 (78)
S64H1-516L	1-5/16	C	1.85 (47)	1.49 (38)	1.18 (30)	3.15 (80)	S64M24L	24	B	1.33 (34)	1.33 (34)	0.82 (21)	3.07 (78)
S64H1-38L	1-3/8	C	1.96 (50)	1.49 (38)	1.18 (30)	3.15 (80)	S64M25L	25	B	1.37 (35)	1.37 (35)	0.82 (21)	3.07 (78)
S64H1-716L	1-7/16	C	2.00 (51)	1.49 (38)	1.18 (30)	3.15 (80)	S64M26L	26	B	1.41 (36)	1.41 (36)	0.82 (21)	3.07 (78)
S64H1-12L	1-1/2	C	2.08 (53)	1.49 (38)	1.18 (30)	3.15 (80)	S64M27L	27	B	1.49 (38)	1.49 (38)	0.82 (21)	3.07 (78)
S64H1-916L	1-9/16	C	2.16 (55)	1.73 (44)	1.29 (33)	3.54 (90)	S64M28L	28	C	1.57 (40)	1.49 (38)	0.94 (24)	3.07 (78)
S64H1-58L	1-5/8	C	2.28 (58)	1.73 (44)	1.29 (33)	3.54 (90)	S64M29L	29	C	1.57 (40)	1.49 (38)	0.94 (24)	3.07 (78)
S64H1-1116L	1-11/16	C	2.40 (61)	1.73 (44)	1.29 (33)	3.54 (90)	S64M30L	30	C	1.65 (42)	1.49 (38)	0.94 (24)	3.07 (78)
S64H1-34L	1-3/4	C	2.48 (63)	1.73 (44)	1.29 (33)	3.54 (90)	S64M32L	32	C	1.73 (44)	1.49 (38)	0.94 (24)	3.07 (78)
S64H1-1316L	1-13/16	C	2.55 (65)	1.73 (44)	1.37 (35)	3.54 (90)	S64M33L	33	C	1.77 (45)	1.49 (38)	0.94 (24)	3.07 (78)
S64H1-78L	1-7/8	C	2.59 (66)	1.73 (44)	1.37 (35)	3.54 (90)	S64M34L	34	C	1.89 (48)	1.49 (38)	0.94 (24)	3.07 (78)
S64H1-1516L	1-15/16	C	2.67 (68)	1.73 (44)	1.37 (35)	3.54 (90)	S64M35L	35	C	1.89 (48)	1.49 (38)	0.94 (24)	3.07 (78)
S64H2L	2	C	2.75 (70)	2.04 (52)	1.37 (35)	3.54 (90)	S64M36L	36	C	1.96 (50)	1.49 (38)	0.94 (24)	3.07 (78)
S64H2-116	2-1/16	C	2.83 (72)	2.04 (52)	1.37 (35)	3.54 (90)							
S64H2-18L	2-1/8	C	2.99 (76)	2.04 (52)	1.37 (35)	3.54 (90)							
S64H2-316L	2-3/16	C	3.03 (77)	2.04 (52)	1.37 (35)	3.54 (90)							
S64H2-14L	2-1/4	C	3.15 (80)	2.04 (52)	1.37 (35)	3.54 (90)							

1/2" Drive

1/2" square drive sockets
 Douilles pour entraineur 1/2"
 1/2" Vierkant Steckschlüssel
 Bocas de cuadrado 1/2"
 Bussole con attacco da 1/2"

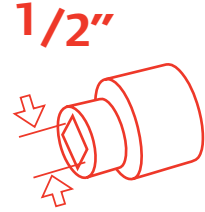

Universal

Part #	Output Size	Type	D1 in (mm)	D2 in (mm)	T in (mm)	L in (mm)
SAE (in)						
S64H516U	5/16	A	0.74 (19)	1.10 (28)	0.51 (13)	2.59 (66)
S64H38U	3/8	A	0.74 (19)	1.10 (28)	0.51 (13)	2.59 (66)
S64H716U	7/16	A	0.74 (19)	1.10 (28)	0.51 (13)	2.59 (66)
S64H12U	1/2	A	0.74 (19)	1.10 (28)	0.51 (13)	2.59 (66)
S64H916U	9/16	A	0.86 (22)	1.10 (28)	0.51 (13)	2.59 (66)
S64H58U	5/8	A	0.94 (24)	1.10 (28)	0.51 (13)	2.59 (66)
S64H1116U	11/16	A	1.02 (26)	1.10 (28)	0.51 (13)	2.59 (66)
S64H34U	3/4	A	1.10 (28)	1.10 (28)	0.51 (13)	2.59 (66)
S64H1316U	13/16	A	1.18 (30)	1.10 (28)	0.51 (13)	2.59 (66)
S64H78U	7/8	A	1.26 (32)	1.10 (28)	0.51 (13)	2.59 (66)
S64H1516U	15/16	A	1.41 (36)	1.10 (28)	0.51 (13)	2.59 (66)
Metric (mm)						
S64M10U	10	A	0.74 (19)	1.10 (28)	0.51 (13)	2.59 (66)
S64M11U	11	A	0.74 (19)	1.10 (28)	0.51 (13)	2.59 (66)
S64M12U	12	A	0.74 (19)	1.10 (28)	0.51 (13)	2.59 (66)
S64M13U	13	A	0.86 (22)	1.10 (28)	0.51 (13)	2.59 (66)
S64M14U	14	A	0.86 (22)	1.10 (28)	0.51 (13)	2.59 (66)
S64M15U	15	A	0.90 (23)	1.10 (28)	0.51 (13)	2.59 (66)
S64M16U	16	A	1.02 (26)	1.10 (28)	0.51 (13)	2.59 (66)
S64M17U	17	A	1.02 (26)	1.10 (28)	0.51 (13)	2.59 (66)
S64M18U	18	A	1.02 (26)	1.10 (28)	0.51 (13)	2.59 (66)
S64M19U	19	A	1.10 (28)	1.10 (28)	0.51 (13)	2.59 (66)
S64M20U	20	A	1.18 (30)	1.10 (28)	0.51 (13)	2.59 (66)
S64M21U	21	A	1.18 (30)	1.10 (28)	0.51 (13)	2.59 (66)
S64M22U	22	A	1.26 (32)	1.10 (28)	0.51 (13)	2.59 (66)
S64M23U	23	A	1.26 (32)	1.10 (28)	0.51 (13)	2.59 (66)
S64M24U	24	A	1.33 (34)	1.10 (28)	0.51 (13)	2.59 (66)



Universal Deep

Part #	Output Size	Type	D1 in (mm)	D2 in (mm)	T in (mm)	L in (mm)
SAE (in)						
S64H38UL	3/8	A	0.86 (22)	1.10 (28)	0.55 (14)	3.54 (90)
S64H716UL	7/16	A	0.86 (22)	1.10 (28)	0.66 (17)	3.54 (90)
S64H12UL	1/2	A	0.86 (22)	1.10 (28)	0.66 (17)	3.54 (90)
S64H916UL	9/16	A	0.86 (22)	1.10 (28)	0.66 (17)	3.54 (90)
S64H58UL	5/8	A	0.94 (24)	1.10 (28)	0.66 (17)	3.54 (90)
S64H1116UL	11/16	A	1.02 (26)	1.10 (28)	0.66 (17)	3.54 (90)
S64H34UL	3/4	A	1.10 (28)	1.10 (28)	0.66 (17)	3.54 (90)
S64H1316UL	13/16	A	1.18 (30)	1.10 (28)	0.66 (17)	3.54 (90)
S64H78UL	7/8	A	1.26 (32)	1.10 (28)	0.66 (17)	3.54 (90)
S64H1516UL	15/16	A	1.33 (34)	1.10 (28)	0.66 (17)	3.54 (90)
Metric (mm)						
S64M10UL	10	A	0.86 (22)	1.10 (28)	0.55 (14)	3.54 (90)
S64M11UL	11	A	0.86 (22)	1.10 (28)	0.66 (17)	3.54 (90)
S64M12UL	12	A	0.86 (22)	1.10 (28)	0.66 (17)	3.54 (90)
S64M13UL	13	A	0.86 (22)	1.10 (28)	0.66 (17)	3.54 (90)
S64M14UL	14	A	0.86 (22)	1.10 (28)	0.66 (17)	3.54 (90)
S64M15UL	15	A	0.94 (24)	1.10 (28)	0.66 (17)	3.54 (90)
S64M16UL	16	A	0.94 (24)	1.10 (28)	0.66 (17)	3.54 (90)
S64M17UL	17	A	1.02 (26)	1.10 (28)	0.66 (17)	3.54 (90)
S64M18UL	18	A	1.02 (26)	1.10 (28)	0.66 (17)	3.54 (90)
S64M19UL	19	A	1.10 (28)	1.10 (28)	0.66 (17)	3.54 (90)
S64M20UL	20	A	1.18 (30)	1.10 (28)	0.66 (17)	3.54 (90)
S64M21UL	21	A	1.18 (30)	1.10 (28)	0.66 (17)	3.54 (90)
S64M22UL	22	A	1.26 (32)	1.10 (28)	0.66 (17)	3.54 (90)
S64M23UL	23	A	1.26 (32)	1.10 (28)	0.66 (17)	3.54 (90)
S64M24UL	24	A	1.33 (34)	1.10 (28)	0.66 (17)	3.54 (90)



Adapters*

Part #	Output Drive Size	Description
A4F3M	3/4	1/2" F to 3/8" M
A4F6M	3/4	1/2" F to 3/4" M
J4	1/2	Universal Joint



Extensions

Part #	Output Drive Size	Description
E43H	1/2	3" Extension
E45H	1/2	5" Extension
E47H	1/2	7" Extension
E410H	1/2	10" Extension
E418H	1/2	18" Extra-Long Extension
E424H	1/2	24" Extra-Long Extension
E436H	1/2	36" Extra-Long Extension

1/2" Drive

3/4"

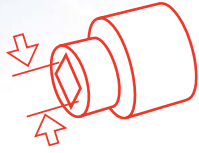

3/4" square drive sockets

Douilles pour entraîneur 3/4"
 3/4" Vierkant Steckschlüssel
 Bocas de cuadrado 3/4"
 Bussole con attacco da 3/4"

Sets

Part #	# of pieces	Description	Contents
SK6H8	8	3/4" Drive SAE, Standard Socket Set	1", 1-1/16", 1-1/8", 1-1/4", 1-5/16", 1-3/8", 1-7/16", 1-1/2"
SK6H8L	8	3/4" Drive SAE Deep Socket Set	1", 1-1/16", 1-1/8", 1-1/4", 1-5/16", 1-3/8", 1-7/16", 1-1/2"



Standard

Part #	Output Size	Type	D1 in (mm)	D2 in (mm)	T in (mm)	L in (mm)
SAE (in)						
S66H12	1/2	A	0.90 (23)	1.63 (41.4)	0.51 (13)	2.00 (51)
S66H916	9/16	A	1.00 (25.5)	1.63 (41.4)	0.51 (13)	2.00 (51)
S66H58	5/8	A	1.10 (28)	1.63 (41.4)	0.51 (13)	2.00 (51)
S66H1116	11/16	A	1.16 (29.5)	1.63 (41.4)	0.51 (13)	2.00 (51)
S66H34	3/4	A	1.26 (32)	1.63 (41.4)	0.51 (13)	2.00 (51)
S66H1316	13/16	A	1.37 (35)	1.63 (41.4)	0.51 (13)	2.00 (51)
S66H78	7/8	A	1.41 (36)	1.63 (41.4)	0.51 (13)	2.00 (51)
S66H1516	15/16	A	1.51 (38.5)	1.63 (41.4)	0.51 (13)	2.00 (51)
S66H1	1	A	1.57 (40)	1.63 (41.4)	0.51 (13)	2.08 (53)
S66H1-116	1-1/16	A	1.67 (42.5)	1.73 (44)	0.51 (13)	2.08 (53)
S66H1-18	1-1/8	B	1.73 (44)	1.73 (44)	0.63 (16)	2.08 (53)
S66H1-316	1-3/16	C	1.81 (46)	1.73 (44)	0.63 (16)	2.08 (53)
S66H1-14	1-1/4	C	1.89 (48)	1.73 (44)	0.63 (16)	2.24 (57)
S66H1-516	1-5/16	C	1.96 (50)	1.73 (44)	0.74 (19)	2.24 (57)
S66H1-38	1-3/8	C	2.06 (52.5)	1.73 (44)	0.74 (19)	2.24 (57)
S66H1-716	1-7/16	C	2.10 (53.5)	1.73 (44)	0.74 (19)	2.24 (57)
S66H1-12	1-1/2	C	2.20 (56)	1.73 (44)	0.86 (22)	2.24 (57)
S66H1-916	1-9/16	C	2.30 (58.5)	1.73 (44)	0.86 (22)	2.28 (58)
S66H1-58	1-5/8	C	2.36 (60)	1.73 (44)	0.86 (22)	2.28 (58)
S66H1-1116	1-11/16	C	2.50 (63.5)	1.73 (44)	1.02 (26)	2.44 (62)
S66H1-34	1-3/4	C	2.53 (64.5)	1.73 (44)	1.02 (26)	2.44 (62)
S66H1-1316	1-13/16	C	2.59 (66)	1.73 (44)	1.02 (26)	2.44 (62)
S66H1-78	1-7/8	C	2.67 (68)	1.73 (44)	1.06 (27)	2.67 (68)
S66H1-1516	1-15/16	C	2.75 (70)	1.73 (44)	1.06 (27)	2.67 (68)
S66H2	2	C	2.79 (71)	1.73 (44)	1.06 (27)	2.67 (68)
S66H2-116	2-1/16	C	2.91 (74)	2.12 (54)	1.22 (31)	2.79 (71)
S66H2-18	2-1/8	C	2.99 (76)	2.12 (54)	1.22 (31)	2.79 (71)
S66H2-316	2-3/16	C	3.07 (78)	2.12 (54)	1.22 (31)	2.79 (71)
S66H2-14	2-1/4	C	3.15 (80)	2.12 (54)	1.29 (33)	2.87 (73)
S66H2-516	2-5/16	C	3.20 (81.5)	2.12 (54)	1.29 (33)	2.87 (73)
S66H2-38	2-3/8	C	3.28 (83.5)	2.12 (54)	1.33 (34)	2.87 (73)
S66H2-716	2-7/16	C	3.34 (85)	2.12 (54)	1.33 (34)	2.95 (75)
S66H2-12	2-1/2	C	3.40 (86.5)	2.12 (54)	1.33 (34)	2.95 (75)
Metric (mm)						
S66M17	17	A	1.18 (30)	1.73 (44)	0.51 (13)	2.00 (51)
S66M18	18	A	1.22 (31)	1.73 (44)	0.51 (13)	2.00 (51)
S66M19	19	A	1.28 (32.5)	1.73 (44)	0.51 (13)	2.00 (51)
S66M20	20	A	1.31 (33.5)	1.73 (44)	0.51 (13)	2.00 (51)
S66M21	21	A	1.37 (35)	1.73 (44)	0.51 (13)	2.00 (51)
S66M22	22	A	1.41 (36)	1.73 (44)	0.51 (13)	2.00 (51)
S66M23	23	A	1.47 (37.5)	1.73 (44)	0.51 (13)	2.00 (51)
S66M24	24	A	1.51 (38.5)	1.73 (44)	0.63 (16)	2.00 (51)
S66M25	25	A	1.57 (40)	1.73 (44)	0.63 (16)	2.08 (53)
S66M26	26	A	1.61 (41)	1.73 (44)	0.63 (16)	2.08 (53)
S66M27	27	A	1.67 (42.5)	1.73 (44)	0.63 (16)	2.08 (53)
S66M28	28	B	1.73 (44)	1.73 (44)	0.74 (19)	2.08 (53)
S66M29	29	C	1.77 (45)	1.73 (44)	0.74 (19)	2.08 (53)
S66M30	30	C	1.81 (46)	1.73 (44)	0.74 (19)	2.08 (53)
S66M31	31	C	1.87 (47.5)	1.73 (44)	0.74 (19)	2.24 (57)
S66M32	32	C	1.90 (48.5)	1.73 (44)	0.74 (19)	2.24 (57)
S66M33	33	C	1.96 (50)	1.73 (44)	0.86 (22)	2.24 (57)
S66M34	34	C	2.00 (51)	1.73 (44)	0.86 (22)	2.24 (57)
S66M35	35	C	2.06 (52.5)	1.73 (44)	0.86 (22)	2.24 (57)
S66M36	36	C	2.10 (53.5)	1.73 (44)	0.86 (22)	2.24 (57)
S66M37	37	C	2.16 (55)	1.73 (44)	0.86 (22)	2.24 (57)
S66M38	38	C	2.20 (56)	1.73 (44)	0.86 (22)	2.24 (57)
S66M40	40	C	2.30 (58.5)	1.73 (44)	0.86 (22)	2.28 (58)
S66M41	41	C	2.36 (60)	1.73 (44)	0.86 (22)	2.28 (58)
S66M42	42	C	2.40 (61)	1.73 (44)	0.98 (25)	2.28 (58)
S66M43	43	C	2.46 (62.5)	1.73 (44)	0.98 (25)	2.44 (62)
S66M44	44	C	2.52 (64)	1.73 (44)	0.98 (25)	2.44 (62)
S66M46	46	C	2.59 (66)	1.73 (44)	0.98 (25)	2.44 (62)
S66M50	50	C	2.79 (71)	1.73 (44)	1.18 (30)	2.67 (68)

3/4" Drive

3/4" square drive sockets
 Douilles pour entraîneur 3/4"
 3/4" Vierkant Steckschlüssel
 Bocas de cuadrado 3/4"
 Bussole con attacco da 3/4"

3/4"

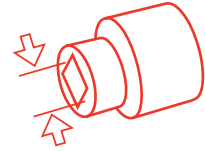

Part #	Output Size	Type	D1 in (mm)	D2 in (mm)	T in (mm)	L in (mm)
SAE (in)						
S66H12L	1/2	A	0.90 (23)	1.63 (41.4)	0.63 (16)	3.54 (90)
S66H916L	9/16	A	1.00 (25.5)	1.63 (41.4)	0.63 (16)	3.54 (90)
S66H58L	5/8	A	1.10 (28)	1.63 (41.4)	0.63 (16)	3.54 (90)
S66H1116L	11/16	A	1.16 (29.5)	1.63 (41.4)	0.63 (16)	3.54 (90)
S66H34L	3/4	A	1.26 (32)	1.63 (41.4)	0.63 (16)	3.54 (90)
S66H1316L	13/16	A	1.37 (35)	1.63 (41.4)	0.63 (16)	3.54 (90)
S66H78L	7/8	A	1.41 (36)	1.63 (41.4)	0.63 (16)	3.54 (90)
S66H1516L	15/16	A	1.51 (38.5)	1.63 (41.4)	0.63 (16)	3.54 (90)
S66H1L	1	A	1.57 (40)	1.63 (41.4)	0.63 (16)	3.54 (90)
S66H1-116L	1-1/16	A	1.67 (42.5)	1.73 (44)	0.63 (16)	3.54 (90)
S66H1-18L	1-1/8	B	1.73 (44)	1.73 (44)	0.63 (16)	3.54 (90)
S66H1-316L	1-3/16	C	1.81 (46)	1.73 (44)	0.63 (16)	3.54 (90)
S66H1-14L	1-1/4	C	1.90 (48.5)	1.73 (44)	0.63 (16)	3.54 (90)
S66H1-516L	1-5/16	C	1.96 (50)	1.73 (44)	0.86 (22)	3.54 (90)
S66H1-38L	1-3/8	C	2.06 (52.5)	1.73 (44)	0.86 (22)	3.54 (90)
S66H1-716L	1-7/16	C	2.10 (53.5)	1.73 (44)	0.86 (22)	3.54 (90)
S66H1-12L	1-1/2	C	2.20 (56)	1.73 (44)	0.86 (22)	3.54 (90)
S66H1-916L	1-9/16	C	2.30 (58.5)	1.73 (44)	0.86 (22)	3.54 (90)
S66H1-58L	1-5/8	C	2.36 (60)	1.73 (44)	0.86 (22)	3.54 (90)
S66H1-1116L	1-11/16	C	2.50 (63.5)	1.73 (44)	1.06 (27)	3.54 (90)
S66H1-34L	1-3/4	C	2.53 (64.5)	1.73 (44)	1.06 (27)	3.54 (90)
S66H1-1316L	1-13/16	C	2.59 (66)	1.73 (44)	1.06 (27)	3.54 (90)
S66H1-78L	1-7/8	C	2.67 (68)	1.73 (44)	1.06 (27)	3.54 (90)
S66H1-1516L	1-15/16	C	2.75 (70)	1.73 (44)	1.06 (27)	3.54 (90)
S66H2L	2	C	2.79 (71)	1.73 (44)	1.06 (27)	3.54 (90)
S66H2-116L	2-1/16	C	2.91 (74)	2.12 (54)	1.22 (31)	3.93 (100)
S66H2-18L	2-1/8	C	2.99 (76)	2.12 (54)	1.22 (31)	3.93 (100)
S66H2-316L	2-3/16	C	3.07 (78)	2.12 (54)	1.22 (31)	3.93 (100)
S66H2-14L	2-1/4	C	3.15 (80)	2.12 (54)	1.33 (34)	3.93 (100)
S66H2-516L	2-5/16	C	3.20 (81.5)	2.12 (54)	1.33 (34)	4.13 (105)
S66H2-38L	2-3/8	C	3.28 (83.5)	2.12 (54)	1.33 (34)	4.13 (105)
S66H2-716L	2-7/16	C	3.34 (85)	2.12 (54)	1.33 (34)	4.13 (105)
S66H2-12L	2-1/2	C	3.38 (86)	2.12 (54)	1.33 (34)	4.13 (105)
Metric (mm)						
S66M17L	17	A	1.18 (30)	1.73 (44)	0.74 (19)	3.54 (90)
S66M19L	19	A	1.28 (32.5)	1.73 (44)	0.74 (19)	3.54 (90)
S66M20L	20	A	1.31 (33.5)	1.73 (44)	0.74 (19)	3.54 (90)
S66M21L	21	A	1.37 (35)	1.73 (44)	0.74 (19)	3.54 (90)
S66M22L	22	A	1.41 (36)	1.73 (44)	0.74 (19)	3.54 (90)
S66M23L	23	A	1.47 (37.5)	1.73 (44)	0.74 (19)	3.54 (90)
S66M24L	24	A	1.51 (38.5)	1.73 (44)	0.74 (19)	3.54 (90)
S66M25L	25	A	1.57 (40)	1.73 (44)	0.74 (19)	3.54 (90)
S66M26L	26	A	1.61 (41)	1.73 (44)	0.86 (22)	3.54 (90)
S66M27L	27	A	1.67 (42.5)	1.73 (44)	0.86 (22)	3.54 (90)
S66M28L	28	B	1.73 (44)	1.73 (44)	0.86 (22)	3.54 (90)
S66M29L	29	C	1.77 (45)	1.73 (44)	0.86 (22)	3.54 (90)
S66M30L	30	C	1.81 (46)	1.73 (44)	0.86 (22)	3.54 (90)
S66M31L	31	C	1.87 (47.5)	1.73 (44)	0.86 (22)	3.54 (90)
S66M32L	32	C	1.90 (48.5)	1.73 (44)	0.86 (22)	3.54 (90)
S66M33L	33	C	1.96 (50)	1.73 (44)	0.98 (25)	3.54 (90)
S66M34L	34	C	2.00 (51)	1.73 (44)	0.98 (25)	3.54 (90)
S66M35L	35	C	2.06 (52.5)	1.73 (44)	0.98 (25)	3.54 (90)
S66M36L	36	C	2.10 (53.5)	1.73 (44)	0.98 (25)	3.54 (90)
S66M38L	38	C	2.20 (56)	1.73 (44)	0.98 (25)	3.54 (90)
S66M40L	40	C	2.30 (58.5)	1.73 (44)	1.18 (30)	3.54 (90)
S66M41L	41	C	2.36 (60)	1.73 (44)	1.18 (30)	3.54 (90)
S66M42L	42	C	2.40 (61)	1.73 (44)	1.18 (30)	3.54 (90)
S66M43L	43	C	2.46 (62.5)	1.73 (44)	1.18 (30)	3.54 (90)
S66M44L	44	C	2.52 (64)	1.73 (44)	1.18 (30)	3.54 (90)
S66M46L	46	C	2.59 (66)	1.73 (44)	1.18 (30)	3.54 (90)
S66M50L	50	C	2.79 (71)	1.73 (44)	1.18 (30)	3.54 (90)

3/4"
Drive

3/4"

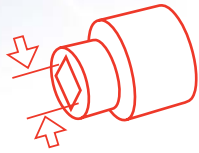

3/4" square drive sockets

Douilles pour entraîneur 3/4"

3/4" Vierkant Steckschlüssel

Bocas de cuadrado 3/4"

Bussole con attacco da 3/4"



Universal

A

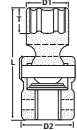

Part #	Output Size	Type	D1 in (mm)	D2 in (mm)	T in (mm)	L in (mm)
SAE (in)						
S66H116U	11/16	A	1.14 (29)	1.73 (44)	0.51 (13)	3.74 (95)
S66H34U	3/4	A	1.26 (32)	1.73 (44)	0.51 (13)	3.74 (95)
S66H1316U	13/16	A	1.37 (35)	1.73 (44)	0.51 (13)	3.74 (95)
S66H78U	7/8	A	1.45 (37)	1.73 (44)	0.51 (13)	3.74 (95)
S66H1516U	15/16	A	1.53 (39)	1.73 (44)	0.51 (13)	3.74 (95)
S66H1U	1	A	1.61 (41)	1.73 (44)	0.51 (13)	3.93 (100)
S66H1-116U	1-1/16	A	1.69 (43)	1.73 (44)	0.66 (17)	3.93 (100)
S66H1-18U	1-1/8	A	1.73 (44)	1.73 (44)	0.66 (17)	3.93 (100)
S66H1-316U	1-3/16	A	1.85 (47)	1.73 (44)	0.66 (17)	3.93 (100)
S66H1-14U	1-1/4	A	1.92 (49)	1.73 (44)	0.66 (17)	4.13 (105)
S66H1-516U	1-5/16	A	2.00 (51)	1.73 (44)	0.74 (19)	4.13 (105)
S66H1-38U	1-3/8	A	2.08 (53)	1.73 (44)	0.74 (19)	4.13 (105)
S66H1-716U	1-7/16	A	2.12 (54)	1.73 (44)	0.74 (19)	4.33 (110)
S66H1-12U	1-1/2	A	2.24 (57)	1.73 (44)	0.86 (22)	4.33 (110)
S66H1-916U	1-9/16	A	2.36 (60)	1.73 (44)	0.86 (22)	4.33 (110)
S66H1-58U	1-5/8	A	2.36 (60)	1.73 (44)	0.86 (22)	4.52 (115)
S66H1-1116U	1-11/16	A	2.48 (63)	1.73 (44)	1.06 (27)	4.52 (115)
S66H1-34U	1-3/4	A	2.52 (64)	1.73 (44)	1.06 (27)	4.52 (115)
S66H1-1316U	1-13/16	A	2.59 (66)	1.73 (44)	1.06 (27)	4.52 (115)
S66H1-78U	1-7/8	A	2.67 (68)	1.73 (44)	1.06 (27)	4.52 (115)

Part #	Output Size	Type	D1 in (mm)	D2 in (mm)	T in (mm)	L in (mm)
Metric (mm)						
S66M17U	17	A	1.14 (29)	1.73 (44)	0.47 (12)	3.74 (95)
S66M19U	19	A	1.26 (32)	1.73 (44)	0.47 (12)	3.74 (95)
S66M20U	20	A	1.33 (34)	1.73 (44)	0.47 (12)	3.74 (95)
S66M21U	21	A	1.37 (35)	1.73 (44)	0.47 (12)	3.74 (95)
S66M22U	22	A	1.45 (37)	1.73 (44)	0.55 (14)	3.74 (95)
S66M23U	23	A	1.49 (38)	1.73 (44)	0.55 (14)	3.74 (95)
S66M24U	24	A	1.53 (39)	1.73 (44)	0.55 (14)	3.93 (100)
S66M25U	25	A	1.61 (41)	1.73 (44)	0.55 (14)	3.93 (100)
S66M26U	26	A	1.65 (42)	1.73 (44)	0.66 (17)	3.93 (100)
S66M27U	27	A	1.69 (43)	1.73 (44)	0.66 (17)	3.93 (100)
S66M28U	28	A	1.73 (44)	1.73 (44)	0.66 (17)	3.93 (100)
S66M29U	29	A	1.81 (46)	1.73 (44)	0.66 (17)	3.93 (100)
S66M30U	30	A	1.85 (47)	1.73 (44)	0.66 (17)	3.93 (100)
S66M31U	31	A	1.89 (48)	1.73 (44)	0.82 (21)	4.13 (105)
S66M32U	32	A	1.92 (49)	1.73 (44)	0.82 (21)	4.13 (105)
S66M33U	33	A	2.00 (51)	1.73 (44)	0.82 (21)	4.13 (105)
S66M34U	34	A	2.04 (52)	1.73 (44)	0.82 (21)	4.13 (105)
S66M35U	35	A	2.08 (53)	1.73 (44)	0.82 (21)	4.13 (105)
S66M36U	36	A	2.12 (54)	1.73 (44)	0.90 (23)	4.33 (110)
S66M37U	37	A	2.20 (56)	1.73 (44)	0.90 (23)	4.33 (110)
S66M38U	38	A	2.24 (57)	1.73 (44)	0.90 (23)	4.33 (110)
S66M39U	39	A	2.32 (59)	1.73 (44)	0.90 (23)	4.33 (110)
S66M40U	40	A	2.36 (60)	1.73 (44)	0.90 (23)	4.33 (110)
S66M41U	41	A	2.36 (60)	1.73 (44)	1.02 (26)	4.52 (115)
S66M42U	42	A	2.44 (62)	1.73 (44)	1.02 (26)	4.52 (115)
S66M43U	43	A	2.48 (63)	1.73 (44)	1.02 (26)	4.52 (115)
S66M44U	44	A	2.52 (64)	1.73 (44)	1.14 (29)	4.52 (115)
S66M45U	45	A	2.59 (66)	1.73 (44)	1.14 (29)	4.52 (115)
S66M46U	46	A	2.59 (66)	1.73 (44)	1.14 (29)	4.52 (115)

3/4" Drive

Adapters*



Part #	Output Drive Size	Description
AGF4M	1/2	3/4" F to 1/2" M
AGF8M	1	3/4" F to 1" M
AGFSSM	#5 Spline	3/4" F to #5 Spline M
J6	3/4	Universal Joint

Extensions



Part #	Output Drive Size	Description
E63H	3/4	3" Extension
E67H	3/4	7" Extension
E610H	3/4	10" Extension
E613H	3/4	13" Extra-Long Extension

1" square drive sockets
 Douilles pour entraîner 1"
 1" Vierkant Steckschlüssel
 Bocas de cuadrado 1"
 Bussole con attacco da 1"

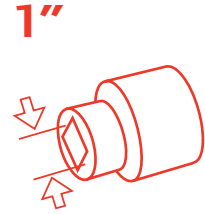

Sets*

Part #	# of pieces	Description	Contents
SK8H8	8	1" Drive SAE Standard Socket Set	7/8", 15/16", 1", 1-1/16", 1-1/8", 1-3/16", 1-1/4", 1-1/2"
SK8H8L	8	1" Drive SAE Deep Socket Set	7/8", 15/16", 1", 1-1/16", 1-1/8", 1-3/16", 1-1/4", 1-1/2"
SK8H9T	9	1" Drive SAE Truck Service Socket Set	13/16" square; 7/8", 15/16", 1", 1-3/16", 1-1/2" hex; 1-1/16", 1-1/8", 1-1/4" deep thin wall hex
SK8C5T	5	1" Drive Combo SAE & Metric Deep Truck Service Socket Set	13/16" square; 33mm & 1-1/2" deep hex; 1-1/8" & 1-1/4" deep thin wall hex



SKH8H



SKH8HL



SK8H9T



SK8C5T

1"
Drive

1"

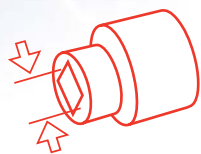

1" square drive sockets

Douilles pour entraîneur 1"
 1" Vierkant Steckschlüssel
 Bocas de cuadrado 1"
 Bussole con attacco da 1"



Standard

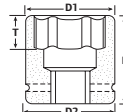

Part #	Output Size	Type	D1 in (mm)	D2 in (mm)	T in (mm)	L in (mm)
SAE (in)						
S68H34	3/4	A	1.37 (35)	2.12 (54)	0.66 (17)	2.28 (58)
S68H1316	13/16	A	1.47 (37.5)	2.12 (54)	0.66 (17)	2.28 (58)
S68H78	7/8	A	1.53 (39)	2.12 (54)	0.66 (17)	2.28 (58)
S68H1516	15/16	A	1.59 (40.5)	2.12 (54)	0.66 (17)	2.28 (58)
S68H1	1	A	1.67 (42.5)	2.12 (54)	0.66 (17)	2.36 (60)
S68H1-116	1-1/16	A	1.75 (44.5)	2.12 (54)	0.66 (17)	2.36 (60)
S68H1-18	1-1/8	A	1.81 (46)	2.12 (54)	0.66 (17)	2.44 (62)
S68H1-316	1-3/16	A	1.92 (49)	2.12 (54)	0.66 (17)	2.44 (62)
S68H1-14	1-1/4	B	2.02 (51.5)	2.12 (54)	0.66 (17)	2.48 (63)
S68H1-516	1-5/16	C	2.12 (54)	2.12 (54)	0.74 (19)	2.48 (63)
S68H1-38	1-3/8	C	2.16 (55)	2.12 (54)	0.74 (19)	2.59 (66)
S68H1-716	1-7/16	C	2.22 (56.5)	2.12 (54)	0.74 (19)	2.59 (66)
S68H1-12	1-1/2	C	2.32 (59)	2.12 (54)	0.86 (22)	2.59 (66)
S68H1-916	1-9/16	C	2.40 (61)	2.12 (54)	0.86 (22)	2.59 (66)
S68H1-58	1-5/8	C	2.46 (62.5)	2.12 (54)	0.86 (22)	2.67 (68)
S68H1-1116	1-11/16	C	2.55 (65)	2.12 (54)	0.98 (25)	2.75 (70)
S68H1-34	1-3/4	C	2.65 (67.5)	2.37 (60.3)	0.98 (25)	2.75 (70)
S68H1-1316	1-13/16	C	2.71 (69)	2.37 (60.3)	1.06 (27)	2.83 (72)
S68H1-78	1-7/8	C	2.75 (70)	2.37 (60.3)	1.06 (27)	2.83 (72)
S68H1-1516	1-15/16	C	2.85 (72.5)	2.37 (60.3)	1.06 (27)	2.99 (76)
S68H2	2	C	2.91 (74)	2.37 (60.3)	1.06 (27)	2.99 (76)
S68H2-116	2-1/16	C	3.01 (76.5)	2.37 (60.3)	1.22 (31)	3.15 (80)
S68H2-18	2-1/8	C	3.11 (79)	2.37 (60.3)	1.22 (31)	3.15 (80)
S68H2-316	2-3/16	C	3.15 (80)	2.37 (60.3)	1.22 (31)	3.30 (84)
S68H2-14	2-1/4	C	3.24 (82.5)	2.37 (60.3)	1.33 (34)	3.30 (84)
S68H2-516	2-5/16	C	3.30 (84)	2.37 (60.3)	1.33 (34)	3.30 (84)
S68H2-38	2-3/8	C	3.40 (86.5)	2.37 (60.3)	1.33 (34)	3.46 (88)
S68H2-716	2-7/16	C	3.50 (89)	2.37 (60.3)	1.41 (36)	3.46 (88)
S68H2-12	2-1/2	C	3.60 (91.5)	2.37 (60.3)	1.41 (36)	3.46 (88)
S68H2-916	2-9/16	C	3.64 (92.5)	2.37 (60.3)	1.41 (36)	3.62 (92)
S68H2-58	2-5/8	C	3.74 (95)	2.37 (60.3)	1.49 (38)	3.62 (92)
S68H2-1116	2-11/16	C	3.79 (96.5)	2.37 (60.3)	1.49 (38)	3.78 (96)
S68H2-34	2-3/4	C	3.89 (99)	2.37 (60.3)	1.49 (38)	3.78 (96)
S68H2-1316	2-13/16	C	3.99 (101.5)	2.37 (60.3)	1.61 (41)	3.78 (96)
S68H2-78	2-7/8	C	4.03 (102.5)	2.37 (60.3)	1.61 (41)	3.78 (96)
S68H2-1516	2-15/16	C	4.11 (104.5)	2.37 (60.3)	1.61 (41)	3.93 (100)
S68H3	3	C	4.19 (106.5)	2.37 (60.3)	1.73 (44)	3.93 (100)
S68H3-18	3-1/8	C	4.37 (111)	2.37 (60.3)	1.73 (44)	3.93 (100)
S68H3-14	3-1/4	C	4.52 (115)	3.38 (86)	1.73 (44)	4.01 (102)
S68H3-38	3-3/8	C	4.68 (119)	3.38 (86)	1.92 (49)	4.17 (106)
S68H3-12	3-1/2	C	4.88 (124)	3.38 (86)	1.92 (49)	4.25 (108)
S68H3-58	3-5/8	C	5.00 (127)	3.38 (86)	2.08 (53)	4.33 (110)
S68H3-34	3-3/4	C	5.11 (130)	3.38 (86)	2.08 (53)	4.33 (110)
S68H3-78	3-7/8	C	5.35 (136)	3.74 (95)	2.20 (56)	4.52 (115)
S68H4	4	C	5.51 (140)	3.74 (95)	2.20 (56)	4.52 (115)
S68H4-18	4-1/8	C	5.63 (143)	3.74 (95)	2.32 (59)	4.72 (120)
S68H4-14	4-1/4	C	5.74 (146)	3.74 (95)	2.32 (59)	4.72 (120)
S68H4-38	4-3/8	C	5.86 (149)	3.74 (95)	2.40 (61)	4.72 (120)
S68H4-12	4-1/2	C	5.98 (152)	3.74 (95)	2.40 (61)	4.72 (120)

Part #	Output Size	Type	D1 in (mm)	D2 in (mm)	T in (mm)	L in (mm)
Metric (mm)						
S68M19	19	A	1.37 (35)	2.12 (54)	0.66 (17)	2.28 (58)
S68M21	21	A	1.47 (37.5)	2.12 (54)	0.66 (17)	2.28 (58)
S68M22	22	A	1.53 (39)	2.12 (54)	0.66 (17)	2.28 (58)
S68M23	23	A	1.57 (40)	2.12 (54)	0.66 (17)	2.28 (58)
S68M24	24	A	1.63 (41.5)	2.12 (54)	0.66 (17)	2.28 (58)
S68M25	25	A	1.67 (42.5)	2.12 (54)	0.66 (17)	2.36 (60)
S68M26	26	A	1.73 (44)	2.12 (54)	0.66 (17)	2.36 (60)
S68M27	27	A	1.77 (45)	2.12 (54)	0.66 (17)	2.36 (60)
S68M28	28	A	1.83 (46.5)	2.12 (54)	0.66 (17)	2.36 (60)
S68M29	29	A	1.87 (47.5)	2.12 (54)	0.74 (19)	2.44 (62)
S68M30	30	A	1.92 (49)	2.12 (54)	0.74 (19)	2.44 (62)
S68M31	31	A	1.96 (50)	2.12 (54)	0.74 (19)	2.44 (62)
S68M32	32	A	2.02 (51.5)	2.12 (54)	0.74 (19)	2.48 (63)
S68M33	33	A	2.06 (52.5)	2.12 (54)	0.82 (21)	2.48 (63)
S68M34	34	B	2.12 (54)	2.12 (54)	0.82 (21)	2.48 (63)
S68M35	35	C	2.16 (55)	2.12 (54)	0.82 (21)	2.59 (66)
S68M36	36	C	2.22 (56.5)	2.12 (54)	0.90 (23)	2.59 (66)
S68M38	38	C	2.32 (59)	2.12 (54)	0.90 (23)	2.59 (66)
S68M40	40	C	2.40 (61)	2.12 (54)	0.90 (23)	2.59 (66)
S68M41	41	C	2.46 (62.5)	2.12 (54)	0.98 (25)	2.67 (68)
S68M42	42	C	2.52 (64)	2.12 (54)	0.98 (25)	2.67 (68)
S68M43	43	C	2.55 (65)	2.12 (54)	0.98 (25)	2.75 (70)
S68M45	45	C	2.65 (67.5)	2.12 (54)	0.98 (25)	2.75 (70)
S68M46	46	C	2.71 (69)	2.12 (54)	1.14 (29)	2.83 (72)
S68M48	48	C	2.81 (71.5)	2.12 (54)	1.14 (29)	2.99 (76)
S68M50	50	C	2.91 (74)	2.12 (54)	1.22 (31)	2.99 (76)
S68M52	52	C	3.01 (76.5)	2.12 (54)	1.22 (31)	3.15 (80)
S68M54	54	C	3.11 (79)	2.12 (54)	1.22 (31)	3.15 (80)
S68M55	55	C	3.15 (80)	2.12 (54)	1.33 (34)	3.30 (84)
S68M56	56	C	3.20 (81.5)	2.12 (54)	1.33 (34)	3.30 (84)
S68M58	58	C	3.30 (84)	2.12 (54)	1.33 (34)	3.30 (84)
S68M60	60	C	3.40 (86.5)	2.12 (54)	1.37 (35)	3.46 (88)
S68M65	65	C	3.64 (92.5)	2.12 (54)	1.37 (35)	3.62 (92)
S68M70	70	C	3.89 (99)	2.12 (54)	1.37 (35)	3.78 (96)
S68M75	75	C	4.13 (105)	2.37 (60.3)	1.37 (35)	4.01 (102)
S68M80	80	C	4.39 (111.5)	2.37 (60.3)	1.37 (35)	4.01 (102)
S68M85	85	C	4.62 (117.5)	3.38 (86)	1.37 (35)	4.17 (106)
S68M90	90	C	4.88 (124)	3.38 (86)	1.37 (35)	4.25 (108)
S68M95	95	C	5.11 (130)	3.38 (86)	1.37 (35)	4.33 (110)

1" Drive

1" square drive sockets
 Douilles pour entraîneur 1"
 1" Vierkant Steckschlüssel
 Bocas de cuadradillo 1"
 Bussole con attacco da 1"

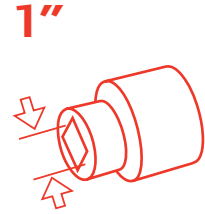

SAE (in)							Metric (mm)						
Part #	Output Size	Type	D1 in (mm)	D2 in (mm)	T in (mm)	L in (mm)	Part #	Output Size	Type	D1 in (mm)	D2 in (mm)	T in (mm)	L in (mm)
S68H34L	3/4	A	1.37 (35)	2.12 (54)	0.98 (25)	3.54 (90)	S68M19L	19	A	1.37 (35)	2.12 (54)	0.98 (25)	3.54 (90)
S68H1316L	13/16	A	1.45 (37)	2.12 (54)	0.98 (25)	3.54 (90)	S68M21L	21	A	1.47 (37.5)	2.12 (54)	0.98 (25)	3.54 (90)
S68H78L	7/8	A	1.53 (39)	2.12 (54)	0.98 (25)	3.54 (90)	S68M22L	22	A	1.53 (39)	2.12 (54)	0.98 (25)	3.54 (90)
S68H1516L	15/16	A	1.59 (40.5)	2.12 (54)	0.98 (25)	3.54 (90)	S68M23L	23	A	1.57 (40)	2.12 (54)	0.98 (25)	3.54 (90)
S68H1L	1	A	1.67 (42.5)	2.12 (54)	0.98 (25)	3.54 (90)	S68M24L	24	A	1.63 (41.5)	2.12 (54)	0.98 (25)	3.54 (90)
S68H1-116L	1-1/16	A	1.75 (44.5)	2.12 (54)	0.98 (25)	3.54 (90)	S68M25L	25	A	1.67 (42.5)	2.12 (54)	0.98 (25)	3.54 (90)
S68H1-18L	1-1/8	A	1.81 (46)	2.12 (54)	0.98 (25)	3.54 (90)	S68M26L	26	A	1.73 (44)	2.12 (54)	0.98 (25)	3.54 (90)
S68H1-316L	1-3/16	A	1.92 (49)	2.12 (54)	0.98 (25)	3.54 (90)	S68M27L	27	A	1.77 (45)	2.12 (54)	0.98 (25)	3.54 (90)
S68H1-14L	1-1/4	A	2.02 (51.5)	2.12 (54)	0.98 (25)	3.54 (90)	S68M28L	28	A	1.83 (46.5)	2.12 (54)	0.98 (25)	3.54 (90)
S68H1-516L	1-5/16	B	2.12 (54)	2.12 (54)	0.98 (25)	3.54 (90)	S68M29L	29	A	1.87 (47.5)	2.12 (54)	0.98 (25)	3.54 (90)
S68H1-38L	1-3/8	C	2.16 (55)	2.12 (54)	0.98 (25)	3.54 (90)	S68M30L	30	A	1.92 (49)	2.12 (54)	0.98 (25)	3.54 (90)
S68H1-716L	1-7/16	C	2.22 (56.5)	2.12 (54)	0.98 (25)	3.54 (90)	S68M31L	31	A	1.96 (50)	2.12 (54)	0.98 (25)	3.54 (90)
S68H1-12L	1-1/2	C	2.32 (59)	2.12 (54)	0.98 (25)	3.54 (90)	S68M32L	32	A	2.02 (51.5)	2.12 (54)	0.98 (25)	3.54 (90)
S68H1-916L	1-9/16	C	2.40 (61)	2.12 (54)	0.98 (25)	3.54 (90)	S68M33L	33	A	2.06 (52.5)	2.12 (54)	0.98 (25)	3.54 (90)
S68H1-58L	1-5/8	C	2.46 (62.5)	2.12 (54)	0.98 (25)	3.54 (90)	S68M34L	34	B	2.12 (54)	2.12 (54)	0.98 (25)	3.54 (90)
S68H1-1116L	1-11/16	C	2.55 (65)	2.12 (54)	0.98 (25)	3.54 (90)	S68M35L	35	C	2.16 (55)	2.12 (54)	0.98 (25)	3.54 (90)
S68H1-34L	1-3/4	C	2.65 (67.5)	2.37 (60.3)	1.22 (31)	3.93 (100)	S68M36L	36	C	2.22 (56.5)	2.12 (54)	0.98 (25)	3.54 (90)
S68H1-1316L	1-13/16	C	2.71 (69)	2.37 (60.3)	1.22 (31)	3.93 (100)	S68M37L	37	C	2.28 (58)	2.12 (54)	0.98 (25)	3.54 (90)
S68H1-78L	1-7/8	C	2.75 (70)	2.37 (60.3)	1.22 (31)	3.93 (100)	S68M38L	38	C	2.32 (59)	2.12 (54)	0.98 (25)	3.54 (90)
S68H1-1516L	1-15/16	C	2.85 (72.5)	2.37 (60.3)	1.22 (31)	3.93 (100)	S68M40L	40	C	2.40 (61)	2.12 (54)	0.98 (25)	3.54 (90)
S68H2L	2	C	2.91 (74)	2.37 (60.3)	1.22 (31)	3.93 (100)	S68M41L	41	C	2.46 (62.5)	2.12 (54)	0.98 (25)	3.54 (90)
S68H2-116L	2-1/16	C	3.01 (76.5)	2.37 (60.3)	1.22 (31)	3.93 (100)	S68M42L	42	C	2.52 (64)	2.12 (54)	0.98 (25)	3.54 (90)
S68H2-18L	2-1/8	C	3.11 (79)	2.37 (60.3)	1.22 (31)	4.25 (108)	S68M43L	43	C	2.55 (65)	2.12 (54)	0.98 (25)	3.54 (90)
S68H2-316L	2-3/16	C	3.15 (80)	2.37 (60.3)	1.22 (31)	4.25 (108)	S68M45L	45	C	2.65 (67.5)	2.12 (54)	1.18 (30)	3.93 (100)
S68H2-14L	2-1/4	C	3.24 (82.5)	2.37 (60.3)	1.41 (36)	4.25 (108)	S68M46L	46	C	2.71 (69)	2.12 (54)	1.18 (30)	3.93 (100)
S68H2-516L	2-5/16	C	3.30 (84)	2.37 (60.3)	1.41 (36)	4.25 (108)	S68M48L	48	C	2.81 (71.5)	2.12 (54)	1.18 (30)	3.93 (100)
S68H2-38L	2-3/8	C	3.40 (86.5)	2.37 (60.3)	1.41 (36)	4.25 (108)	S68M50L	50	C	2.91 (74)	2.12 (54)	1.18 (30)	3.93 (100)
S68H2-716L	2-7/16	C	3.50 (89)	2.37 (60.3)	1.41 (36)	4.25 (108)	S68M52L	52	C	3.01 (76.5)	2.12 (54)	1.18 (30)	3.93 (100)
S68H2-12L	2-1/2	C	3.60 (91.5)	2.37 (60.3)	1.41 (36)	4.72 (120)	S68M54L	54	C	3.11 (79)	2.12 (54)	1.37 (35)	4.25 (108)
S68H2-916L	2-9/16	C	3.64 (92.5)	2.37 (60.3)	1.41 (36)	4.72 (120)	S68M55L	55	C	3.15 (80)	2.12 (54)	1.37 (35)	4.25 (108)
S68H2-58L	2-5/8	C	3.74 (95)	2.37 (60.3)	1.73 (44)	4.72 (120)	S68M56L	56	C	3.20 (81.5)	2.12 (54)	1.37 (35)	4.25 (108)
S68H2-1116L	2-11/16	C	3.79 (96.5)	2.37 (60.3)	1.73 (44)	4.72 (120)	S68M58L	58	C	3.30 (84)	2.12 (54)	1.37 (35)	4.25 (108)
S68H2-34L	2-3/4	C	3.89 (99)	2.37 (60.3)	1.73 (44)	4.92 (125)	S68M60L	60	C	3.40 (86.5)	2.12 (54)	1.37 (35)	4.25 (108)
S68H2-1316L	2-13/16	C	3.99 (101.5)	2.37 (60.3)	1.73 (44)	4.92 (125)	S68M65L	65	C	3.64 (92.5)	2.12 (54)	1.37 (35)	4.72 (120)
S68H2-78L	2-7/8	C	4.03 (102.5)	2.37 (60.3)	1.73 (44)	4.92 (125)	S68M70L	70	C	3.89 (99)	2.12 (54)	1.37 (35)	4.92 (125)
S68H2-1516L	2-15/16	C	4.11 (104.5)	2.37 (60.3)	1.73 (44)	4.92 (125)	S68M75L	75	C	4.13 (105)	2.37 (60.3)	1.37 (35)	4.92 (125)
S68H3L	3	C	4.19 (106.5)	2.37 (60.3)	1.73 (44)	4.92 (125)	S68M80L	80	C	4.39 (111.5)	2.37 (60.3)	1.37 (35)	4.92 (125)
S68H3-18L	3-1/8	C	4.39 (111.5)	2.37 (60.3)	1.73 (44)	4.92 (125)	S68M85L	85	C	4.52 (115)	3.38 (86)	1.37 (35)	5.31 (135)
S68H3-14L	3-1/4	C	4.44 (113)	3.38 (86)	1.73 (44)	5.31 (135)	S68M90L	90	C	4.88 (124)	3.38 (86)	1.37 (35)	5.31 (135)
S68H3-38L	3-3/8	C	4.52 (115)	3.38 (86)	2.20 (56)	5.31 (135)	S68M95L	95	C	5.11 (130)	3.38 (86)	1.37 (35)	5.51 (140)
S68H3-12L	3-1/2	C	4.68 (119)	3.38 (86)	2.20 (56)	5.31 (135)							
S68H3-58L	3-5/8	C	5.00 (127)	3.38 (86)	2.20 (56)	5.51 (140)							
S68H3-34L	3-3/4	C	5.11 (130)	3.38 (86)	2.20 (56)	5.51 (140)							
S68H3-78L	3-7/8	C	5.35 (136)	3.74 (95)	2.20 (56)	5.51 (140)							
S68H4L	4	C	5.51 (140)	3.74 (95)	2.20 (56)	6.10 (155)							
S68H4-18L	4-1/8	C	5.63 (143)	3.74 (95)	2.40 (61)	6.10 (155)							
S68H4-14L	4-1/4	C	5.74 (146)	3.74 (95)	2.40 (61)	6.10 (155)							
S68H4-38L	4-3/8	C	5.86 (149)	3.74 (95)	2.40 (61)	6.10 (155)							
S68H4-12L	4-1/2	C	5.98 (152)	3.74 (95)	2.40 (61)	6.10 (155)							

1"

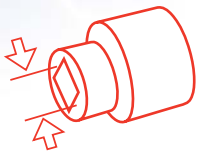

1" square drive sockets

Douilles pour entraîner 1"
 1" Vierkant Steckschlüssel
 Bocas de cuadrado 1"
 Bussole con attacco da 1"

Universal							Metric (mm)						
Part #	Output Size	Type	D1 in (mm)	D2 in (mm)	T in (mm)	L in (mm)	Part #	Output Size	Type	D1 in (mm)	D2 in (mm)	T in (mm)	L in (mm)
SAE (in)													
S68H78U	7/8	A	1.53 (39)	2.12 (54)	0.74 (19)	5.00 (127)	S68M24U	24	A	1.61 (41)	2.12 (54)	0.66 (17)	5.19 (132)
S68H1516U	15/16	A	1.61 (41)	2.12 (54)	0.74 (19)	5.19 (132)	S68M26U	26	A	1.73 (44)	2.12 (54)	0.66 (17)	5.19 (132)
S68H1-116U	1-1/16	A	1.77 (45)	2.12 (54)	0.74 (19)	5.19 (132)	S68M27U	27	A	1.77 (45)	2.12 (54)	0.66 (17)	5.19 (132)
S68H1-18U	1-1/8	A	1.89 (48)	2.12 (54)	0.74 (19)	5.19 (132)	S68M29U	29	A	1.89 (48)	2.12 (54)	0.66 (17)	5.19 (132)
S68H1-316U	1-3/16	A	1.92 (49)	2.12 (54)	0.74 (19)	5.19 (132)	S68M30U	30	A	1.92 (49)	2.12 (54)	0.66 (17)	5.19 (132)
S68H1-14U	1-1/4	A	2.00 (51)	2.12 (54)	0.74 (19)	5.19 (132)	S68M32U	32	A	2.00 (51)	2.12 (54)	0.86 (22)	5.19 (132)
S68H1-516U	1-5/16	A	2.08 (53)	2.12 (54)	0.74 (19)	5.19 (132)	S68M33U	33	A	2.08 (53)	2.12 (54)	0.86 (22)	5.19 (132)
S68H1-38U	1-3/8	A	2.16 (55)	2.12 (54)	0.74 (19)	5.19 (132)	S68M34U	34	A	2.12 (54)	2.12 (54)	0.86 (22)	5.19 (132)
S68H1-716U	1-7/16	A	2.28 (58)	2.12 (54)	0.74 (19)	5.19 (132)	S68M35U	35	A	2.16 (55)	2.12 (54)	0.86 (22)	5.19 (132)
S68H1-12U	1-1/2	A	2.32 (59)	2.12 (54)	0.98 (25)	5.39 (137)	S68M36U	36	A	2.20 (56)	2.12 (54)	0.86 (22)	5.19 (132)
S68H1-916U	1-9/16	A	2.40 (61)	2.12 (54)	0.98 (25)	5.39 (137)	S68M38U	38	A	2.32 (59)	2.12 (54)	0.98 (25)	5.39 (137)
S68H1-58U	1-5/8	A	2.48 (63)	2.12 (54)	0.98 (25)	5.39 (137)	S68M41U	41	A	2.48 (63)	2.12 (54)	0.98 (25)	5.39 (137)
S68H1-1116U	1-11/16	A	2.55 (65)	2.12 (54)	0.98 (25)	5.39 (137)	S68M42U	42	A	2.52 (64)	2.12 (54)	0.98 (25)	5.39 (137)
S68H1-34U	1-3/4	A	2.63 (67)	2.12 (54)	0.98 (25)	5.39 (137)	S68M43U	43	A	2.55 (65)	2.12 (54)	0.98 (25)	5.39 (137)
S68H1-1316U	1-13/16	A	2.71 (69)	2.12 (54)	1.06 (27)	5.59 (142)	S68M44U	44	A	2.63 (67)	2.12 (54)	0.98 (25)	5.39 (137)
S68H1-78U	1-7/8	A	2.79 (71)	2.12 (54)	1.06 (27)	5.59 (142)	S68M45U	45	A	2.67 (68)	2.12 (54)	1.06 (27)	5.59 (142)
S68H1-1516U	1-15/16	A	2.83 (72)	2.12 (54)	1.06 (27)	5.59 (142)	S68M46U	46	A	2.71 (69)	2.12 (54)	1.06 (27)	5.59 (142)
S68H2U	2	A	2.99 (76)	2.12 (54)	1.06 (27)	5.59 (142)	S68M47U	47	A	2.75 (70)	2.12 (54)	1.06 (27)	5.59 (142)
							S68M48U	48	A	2.79 (71)	2.12 (54)	1.06 (27)	5.59 (142)
							S68M50U	50	A	2.91 (74)	2.12 (54)	1.06 (27)	5.59 (142)

Adapters*

Part #	Output Drive Size	Description
A8F6M	3/4	1" F to 3/4" M
A8F12M	1-1/2	1" F to 1-1/2" M
A8F55M	#5 Spline	1" F to #5 Spline M
J8	1	Universal Joint

Extensions

Part #	Output Drive Size	Description
E83H	1	3" Extension
E87H	1	7" Extension
E810H	1	10" Extension
E813H	1	13" Extra-Long Extension

1" Drive

* Reducing Adapters are not covered under the Lifetime Warranty.

Safety



- Always wear eye protection.
- Always wear hearing protection.
- Sockets may briefly continue their motion after throttle is released.
- Never use a damaged socket. Inspect sockets for signs of irregularities such as fractures, excessive wear, and other flaws which may compromise proper function.
- Always use IR sockets with IR tools. Always attach the socket to the correct drive square size. Never use a standard size for a metric application or vice versa.
- Tool safety manuals can be downloaded from www.irtools.com. Refer all communications to the nearest Ingersoll Rand Office or Distributor.

- Portez toujours des équipements de protection des yeux.
- Utilisez toujours du matériel de protection anti-bruit.
- Il est possible que les douilles continuent de tourner après que la commande soit relâchée.
- N'utilisez jamais une douille endommagée. Inspectez les douilles pour vous assurer qu'elles ne présentent pas d'anomalies telles que des criques, une usure excessive ou autres, qui seraient susceptibles d'en empêcher le fonctionnement normal.
- Utilisez toujours des douilles Ingersoll Rand avec les outils Ingersoll Rand. Fixez toujours la douille sur l'entraîneur carré de taille appropriée. N'utilisez jamais une taille standard pour une application métrique ou vice versa.
- Des manuels de sécurité pour les outils peuvent être téléchargés sur le site www.irtools.com. Adressez toutes les communications à votre agence locale Ingersoll Rand ou votre distributeur.

- Immer eine Schutzbrille tragen.
- Immer Gehörschutz tragen.
- Einsätze drehen sich u.U. nach Loslassen des Drosselschalters kurz weiter.
- Beschädigte Steckschlüsseinsätze nicht verwenden. Steckschlüsseinsätze auf Anzeichen von Fehlern, d.h. Risse, starke Abnutzung und sonstige Beschädigungen prüfen, die eine ordnungsgemäße Funktion beeinträchtigen könnten.
- Ingersoll-Rand-Steckschlüsseinsätze dürfen nur mit Ingersoll-Rand-Werkzeugen verwendet werden. Steckschlüsseinsatz immer auf Antrieb der richtigen Größe setzen. Standardgrößen dürfen nicht für metrisch dimensionierte Anwendungen (und umgekehrt) eingesetzt werden.
- Sicherheitshandbücher für Werkzeuge können von www.irtools.com heruntergeladen werden. Bei Fragen wenden Sie sich bitte an den Ingersoll-Rand-Vertreter oder -Händler in Ihrer Nähe.

- Use siempre protección ocular.
- Use siempre protección auditiva.
- Es posible que las bocas continúen en movimiento por corto tiempo una vez se libera el mando.
- Nunca use una boca dañada. Revise que no haya signos de irregularidades en las bocas, como fisuras, desgaste excesivo u otros defectos que puedan comprometer su correcto funcionamiento.
- Use siempre bocas Ingersoll Rand con herramientas Ingersoll Rand. Fije siempre la boca cuadrado del tamaño adecuado. Nunca use un tamaño estándar para una aplicación métrica o viceversa.
- Puede descargar los manuales de seguridad de herramientas en www.irtools.com. Remita toda comunicación a la oficina o al distribuidor de Ingersoll Rand más cercano.

- Indossare sempre protezioni per gli occhi.
- Usare sempre protezioni auricolari.
- Le bussole possono continuare a muoversi brevemente dopo aver rilasciato il grilletto dell'avvitatore.
- Non usare mai bussole danneggiate. Controllare che le bussole non presentino irregolarità come incrinature, usura eccessiva e altri difetti che ne possano comprometterne il normale funzionamento.
- Usare le chiavi a bussola Ingersoll Rand sempre con utensili Ingersoll Rand. Fissare sempre la chiave al portabussole quadro della misura adatta. Non usare bussole in pollici per bulloneria metrica e viceversa.
- Manuali sulla sicurezza degli utensili possono essere scaricati dal sito www.irtools.com. Inviare tutte le comunicazioni al più vicino ufficio o distributore Ingersoll Rand.

Ingersoll Rand Impact Sockets Lifetime Warranty



Ingersoll Rand Impact Sockets come with a Lifetime Warranty on all manufacturing and material defects. Socket products not included in the Lifetime Warranty program are thin-wall sockets and reducing adaptors. Warranty on socket sets applies to individual sockets only. The Lifetime Warranty does not apply to any product that has been misused, abused, altered in any way, or worn from normal wear and tear. Extended use of Ingersoll Rand Impact Sockets may cause wearing of the electro-phosphate finish. This is a normal occurrence and is not covered under the Lifetime Warranty.

Ingersoll Rand Accessories

Ingersoll Rand offers a full line of top-quality accessories specifically designed to complement our entire product offering. Any manufacturer can provide equipment or aftermarket accessories, but Ingersoll Rand offers a 360-degree, total solutions approach to everything that we do and provide.



- **Power Supply Accessories:** Compressor Accessories, Couplers & Connectors, Fittings & Hoses, FRLs, etc...
- **Work Accessories:** Impact Sockets, Tool Steels, Abrasives & Surface Prep Accessories, Sanding & Polishing Pads, Carbide Grinding Burs, etc...
- **User Accessories:** Gloves, Spring Balancers, Tool Boots, Comfort Grips, etc...
- **Components:** Lubricants, Repair Kits, etc...

For more information, visit our Web site www.irtools.com, order the Ingersoll Rand Accessory Catalog (Form # IR-0605-097), or call **1-800-376-TOOL**.

IR Ingersoll Rand RACING



Proud Sponsors of Everham Motorsports
and the #9 Ultimate Chargers™



SCHLAGE HUSSMANN®

THERMO KING

Club Car



Ingersoll Rand Industrial Technologies provides products, services and solutions to enhance the efficiency and productivity of our commercial, industrial and process customers. Our innovative products include air compressors, air systems components, tools, pumps, material and fluid handling systems and microturbines.

Ingersoll Rand Industrial Technologies fournit des produits, des services et des solutions qui améliorent l'efficacité et la productivité de nos clients commerciaux, industriels et de processus. Nos produits innovants comprennent des compresseurs d'air, des composants de système d'air, des outils, des pompes, des systèmes de manipulation de matériaux et de fluides ainsi que des microturbines.

Ingersoll Rand Industrial Technologies bietet Produkte, Dienstleistungen und Lösungen zur Verbesserung der Effizienz und Produktivität unserer Kunden in den Bereichen Handel, Industrie und Verarbeitung. Zu unseren innovativen Produkten zählen Luftkompressoren, Druckluftkomponenten, Werkzeuge, Pumpen, Material- und Flüssigkeits-Handlingsysteme und Mikroturbinen.

Ingersoll Rand Industrial Technologies suministra productos, servicios y soluciones con la finalidad de mejorar la eficiencia y productividad de nuestros clientes en las áreas comercial, industrial y de procesos. Nuestros productos innovadores incluyen compresores de aire, componentes para sistemas de aire, herramientas, bombas, sistemas de manipulación de materiales y fluidos así como microturbinas.

Ingersoll Rand Industrial Technologies offre prodotti, servizi e soluzioni che migliorano efficienza e produttività dei nostri clienti commerciali, industriali e con tecnologie di processo. Le nostre soluzioni innovative comprendono compressori d'aria, componenti per impianti di aria compressa, utensili, pompe, sistemi per il trattamento e la manipolazione di materiali e fluidi oltre a microturbine.

Ingersoll Rand / Productivity Solutions

Business Development Center
1467 Route 31 South
P.O. Box 970
Annandale, NJ 08801 USA

www.ingersollrand.com